

# ESTRUS SYNCHRONIZATION PROTOCOLS FOR HEIFERS<sup>1</sup>



**D.J. Patterson, D.A. Mallory, J. M. Nash, and M.F. Smith**

*Division of Animal Sciences  
University of Missouri*

## **Introduction**

Estrus synchronization and artificial insemination (AI) remain the most important and widely applicable reproductive biotechnologies available for cattle (Seidel, 1995). Although hormonal treatment of heifers and cows to group estrous cycles has been a commercial reality now for over 30 years, beef producers have been slow to adopt this management practice. Perhaps this is because of past failures, which resulted when females that were placed on estrus synchronization treatments failed to reach puberty or to resume normal estrous cycles following calving. In addition, early estrus synchronization programs failed to manage follicular waves, resulting in more days in the synchronized period, which ultimately precluded fixed-time artificial insemination with acceptable pregnancy rates. The development of convenient and economical protocols to synchronize estrus and ovulation to facilitate use of fixed-time AI (FTAI) with resulting high fertility should result in increased adoption of these important management practices (Patterson et al., 2003). Current research has focused on the development of methods that effectively synchronize estrus in replacement beef heifers and postpartum beef cows by decreasing the period of time over which estrus detection is required, thus facilitating the use of FTAI.

Although tools are now available for beef producers to successfully utilize these procedures, transfer of the technology must assume a high priority. Transfer of this technology to beef producers in the U.S. will require an increase in technical support to facilitate successful use and adoption of these procedures, otherwise the products of our research and technology may be used more effectively in foreign countries whose beef products will ultimately compete with our own (Patterson et al., 2000a).

Improving traits of major economic importance in beef cattle can be accomplished most rapidly through selection of genetically superior sires and widespread use of artificial insemination. Procedures that facilitate synchronization of estrus in estrous cycling females and induction of an ovulatory estrus in peripubertal heifers and anestrus postpartum cows will increase reproductive rates and expedite genetic progress. Estrus synchronization can be an effective means of increasing the proportion of females that become pregnant early in the breeding season resulting in shorter calving seasons and more uniform calf crops (Dziuk and Bellows, 1983). Females that conceived to a synchronized estrus calved earlier in the calving season and weaned calves that

---

<sup>1</sup> Research summarized in this manuscript was supported by National Research Initiative Competitive Grant no. 00-35203-9175 and 2005-55203-15750 from the USDA Cooperative State Research, Education, and Extension Service; and Select Sires, Inc., Plain City, OH. The authors gratefully acknowledge Pfizer Animal Health (New York, NY) for providing Lutalyse sterile suspension and EAZI BREED CIDR Cattle inserts; Merial (Athens, GA) for providing Cystorelin; IVX Animal Health for providing OvaCyst; ABS Global, Accelerated Genetics, Genex, and Select Sires, Inc., for providing semen.

were on average 13 days older and 21 pounds heavier than calves from non-synchronized females (Schafer et al., 1990).

Effective estrus synchronization programs offer the following advantages: 1) cows or heifers are in estrus at a predicted time which facilitates AI, embryo transfer, or other assisted reproductive techniques; 2) the time required for detection of estrus is reduced thus decreasing labor expense associated with estrus detection; 3) cattle will conceive earlier during the breeding period; 4) AI becomes more practical; and 5) calves will be older and heavier at weaning.

*WHY BEEF PRODUCERS DO NOT USE EXISTING AND POTENTIAL TECHNOLOGIES.* Beef producers cite several reasons for the lack of widespread use of AI to breed heifers and cows. These reasons include: lack of time and labor, available procedures are viewed as being too complicated or costly to implement, inadequate means to detect estrus, or inconvenience (NAHMS, 1998). Continuation of low adoption rates of these technologies in the U.S. will ultimately erode the competitive position of the U.S. cattle industry. Other countries are adopting new technologies for animal production more rapidly than the U.S. Beef producers in Brazil artificially inseminate nearly 5 times more cows annually compared with U.S. producers (ASBIA, 2004; NAAB, 2004). Given the current scenario, elite seed stock herds in the U.S. will soon provide a sizeable percentage of the germ plasm used worldwide. Unless, however, owners of commercial cowherds aggressively implement reproductive and genetic improvement, the U.S. will lose its competitive advantage in production of high quality beef. International players that are more technically astute and competitively advantaged will position themselves to dominate the production and sale of beef worldwide.

The inability to predict time of estrus for individual cows or heifers in a group often makes it impractical to use AI because of the labor required for detection of estrus. Available procedures to control the estrous cycle of the cow can improve reproductive rates and speed up genetic progress. These procedures include synchronization of estrus in estrous cycling females, and induction of estrus accompanied by ovulation in heifers that have not yet reached puberty or among cows that have not returned to estrus after calving.

The following protocols and terms will be referred to throughout this manuscript.

*Protocols for AI performed on the basis of detected estrus:*

*PG:* Prostaglandin F<sub>2α</sub> (PG; Lutalyse<sup>®</sup>, Estrumate<sup>®</sup>, ProstaMate<sup>®</sup>, InSynch<sup>®</sup>, estroPLAN<sup>®</sup>).

*MGA-PG:* Melengestrol acetate (MGA; 0.5 mg/hd/day) is fed for a period of 14 days with PG administered 17 to 19 days after MGA withdrawal.

*GnRH-PG (Select Synch):* Gonadotropin-releasing hormone injection (GnRH; Cystorelin<sup>®</sup>, Factrel<sup>®</sup>, Fertagyl<sup>®</sup>, OvaCyst<sup>®</sup>) followed in 7 days with an injection of PG.

*MGA-GnRH-PG (MGA<sup>®</sup> Select):* MGA is fed for 14 days, GnRH is administered 12 days after MGA withdrawal, and PG is administered 7 days after GnRH.

*CIDR Select:* CIDRs are inserted on day 0 and removed on day 14, GnRH is administered on day 23 and PG is administered on day 30.

*14-day CIDR-PG:* CIDRs are inserted on day 0 and removed on day 14. PG is administered on day 30.

Protocols for fixed-time AI in beef heifers:

*CO-Synch + CIDR:* GnRH is administered at CIDR insertion on day 0, followed 7 days later with CIDR removal, and PG. Insemination is performed 54 hours after CIDR removal and PG, with GnRH administered at AI.

*CIDR Select:* CIDRs are inserted on day 0 and removed on day 14, GnRH is administered on day 23 and PG is administered on day 30. Insemination is performed 72 hours after PG with GnRH administered at AI.

*14-day CIDR-PG:* CIDRs are inserted on day 0 and removed on day 14 with PG administered on day 30. Insemination is performed 66 hours after PG with GnRH administered at AI.

Terms:

*Estrous response:* The number of females that exhibit estrus during a synchronized period.

*Synchronized period:* The period of time during which estrus is expressed after treatment.

*Synchronized conception rate:* The proportion of females that became pregnant of those exhibiting estrus and inseminated during the synchronized period.

*Synchronized pregnancy rate:* Proportion of females that become pregnant of the total number treated.

To avoid problems when using estrus synchronization, heifers should be selected for a program when the following conditions are met: 1) Replacement heifers are developed to prebreeding target weights that represent at least 65 percent of their projected mature weight; and 2) Reproductive tract scores (RTS) are assigned to heifers no more than two weeks before a synchronization treatment begins [scores of 2 or higher on a scale of 1 to 5] and at least 50 percent of the heifers are assigned a RTS of 4 or 5 (Patterson et al., 2000a).

### **Estrus Synchronization and AI contribute to Total Heifer Development**

Estrus synchronization and artificial insemination contribute to a total heifer development program in several ways. Estrus synchronization improves time management for producers that use AI by concentrating the breeding and resulting calving periods. Managers are able to spend more time observing heifers as they calve because calving occurs over a shorter time period. Calf losses in many cases are reduced because of improved management during the calving period. Artificial insemination provides the opportunity to breed heifers to bulls selected for low BW or high calving ease EPD with high accuracy. This practice minimizes the incidence and severity of calving difficulty and decreases calf loss that results from dystocia. In addition, heifers that conceive during a synchronized period typically wean calves that are older and heavier at weaning time (Schafer et al., 1990). Finally, heifer calves that result from AI can be an excellent source of future replacements facilitating more rapid improvement in the genetic makeup of an entire herd.

Progestins were used to induce estrus in peripubertal heifers (Gonzalez-Padilla et al., 1975) and were originally combined with estrogen to mimic changes that occur in concentrations of blood hormones around the time of puberty. Increased progesterone is thought to be a prerequisite for the development of normal estrous cycles. Progesterone increases during the initiation of puberty in the heifer (Berardinelli et al., 1979), and before resumption of normal ovarian

cyclicity in postpartum suckled beef cows (Prybil and Butler, 1978; Rawlings et al., 1980). Progestins stimulate an increase in follicular growth that results subsequently in increased production of estrogen by ovarian follicles (Henricks et al., 1973; Wetteman and Hafs, 1973; Sheffel et al., 1982; Garcia-Winder et al., 1986). Melengestrol acetate initiates estrous cyclicity in peripubertal beef heifers (Patterson et al., 1990) and is associated with increased LH pulse frequency during the treatment period (Smith and Day, 1990; Imwalle et al., 1998). Recent studies suggest that the stimulatory effects of progestins on LH secretion are greatest after removal of the steroid (Hall et al., 1997; Imwalle et al., 1998). Furthermore, improvements in observed pubertal induction response following treatment with a progestin occur with an increase in age (Hall et al., 1997). The increase in pulsatile release of LH that occurs in response to progestin treatment in peripubertal heifers results in a decrease in estrogen receptors within neuronal systems that mediate negative feedback actions of estradiol on GnRH secretion (Anderson et al., 1996).

Burfening (1979) suggested that because puberty is a heritable trait, induced puberty in replacement heifers over several generations might result in situations in which attainment of puberty would be difficult without hormone treatment. This consideration cannot be overlooked. However, there is a need to explore treatments to induce puberty in breeds of cattle that are late-maturing but of sufficient age and weight at the time of treatment to permit successful application (Patterson et al., 1990). The decision to utilize this practice within a herd perhaps differs with various types of beef operations. For instance, the common goal of most managers of commercial cow-calf herds is to maximize weaning rate. In other words, the investment in time and resources in a heifer from weaning to breeding requires that management efforts be made to facilitate puberty onset and maximize the likelihood of early pregnancy. In this scenario, a method to induce puberty in heifers could serve as a valuable tool to improve reproductive performance of heifers retained for breeding purposes. On the other hand, seed stock managers should weigh the economic importance of puberty onset in their herds, as well as their customers', and the associated potential and resulting implication of masking its true genetic expression.

### **Development of Methods to Synchronize Estrus**

The development of methods to control the estrous cycle of the cow has occurred in six distinct phases. The physiological basis for estrus synchronization followed the discovery that progesterone inhibited ovulation (Ulberg et al., 1951) and preovulatory follicular maturation (Nellor and Cole, 1956; Hansel et al., 1961; Lamond, 1964). Regulation of estrous cycles was believed to be associated with control of the corpus luteum, whose life span and secretory activity are regulated by trophic and lytic mechanisms (Thimonier et al., 1975; Patterson et al., 2003). The Progesterone Phase included efforts to prolong the luteal phase of the estrous cycle or to establish an artificial luteal phase by administering exogenous progesterone. Later, progestational agents were combined with estrogens or gonadotropins in the Progesterone–Estrogen Phase. Prostaglandin  $F_{2\alpha}$  and its analogs were reported in 1972 to be luteolytic in the bovine (Lauderdale, 1972; Rowson et al., 1972; Liehr et al., 1972; Lauderdale et al., 1974) and ushered in the PG Phase. Treatments that combined progestational agents with PG characterized the Progestogen-PG Phase. All of these protocols addressed control of the luteal phase of the estrous cycle since follicular waves were not recognized at the time.

Precise monitoring of ovarian follicles and corpora lutea over time by transrectal ultrasonography expanded our understanding of the bovine estrous cycle and particularly the change that occurs during a follicular wave (Fortune et al., 1988). Growth of follicles in cattle occurs in distinct wave-like patterns, with new follicular waves occurring approximately every 10 days (6-15 day range). We now know that precise control of estrous cycles requires the manipulation of both follicular waves and luteal lifespan (GnRH-PG Phase).

A single injection of gonadotropin-releasing hormone (GnRH) to cows at random stages of their estrous cycles causes release of luteinizing hormone leading to synchronized ovulation or luteinization of most large dominant follicles ( $\geq 10$  mm; Garverick et al., 1980; Bao and Garverick, 1998; Sartori et al., 2001). Consequently, a new follicular wave is initiated in all cows within 2 to 3 days of GnRH administration. Luteal tissue that forms after GnRH administration is capable of undergoing PG-induced luteolysis 6 or 7 days later (Twagiramungu et al., 1995). The GnRH-PG protocol increased estrus synchronization rate in beef (Twagiramungu et al., 1992a,b) and dairy (Thatcher et al., 1993) cattle. A drawback of this method, however, is that approximately 5 to 15% of the cows are detected in estrus on or before the day of PG injection, thus reducing the proportion of females that are detected in estrus and inseminated during the synchronized period (Kojima et al., 2000). This information stimulated research in the Progestogen-GnRH-PG Phase.

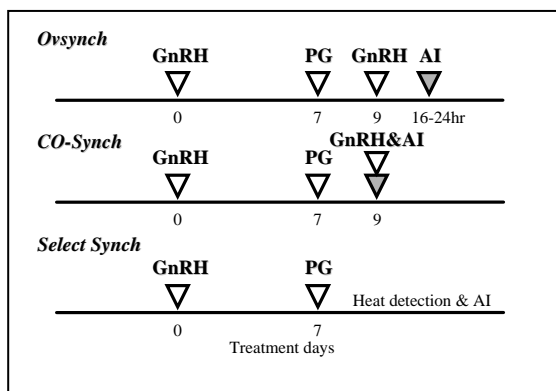
### **Synchronizing Estrus and Ovulation with the GnRH-PG-GnRH Protocol**

Administration of PG alone is commonly utilized to synchronize an ovulatory estrus in estrous cycling heifers and cows. However, this method is ineffective in anestrous females and variation among animals in the stage of the follicular wave at the time of PG injection directly contributes to the variation in onset of estrus during the synchronized period (Macmillan and Henderson, 1984; Sirois and Fortune, 1988). Consequently, the GnRH-PG-GnRH protocol was developed to synchronize follicular waves and timing of ovulation. The GnRH-PG-GnRH protocol (Figure 1) for fixed-time AI results in development of a preovulatory follicle that ovulates in response to a second GnRH-induced LH surge 48 hours after PG injection (Ovsynch; Pursley et al., 1995). Ovsynch was validated as a reliable means of synchronizing ovulation for fixed-time AI in lactating dairy cows (Pursley et al., 1995; Burke et al., 1996; Pursley et al., 1997a, b; Schmitt et al., 1996). Time of ovulation with Ovsynch occurs between 24 to 32 hours after the second GnRH injection and is synchronized in 87 to 100% of lactating dairy cows (Pursley et al., 1997a). Pregnancy rates among cows that were inseminated at a fixed time following Ovsynch ranged from 32 to 45% (Pursley et al., 1997b; 1998). The Ovsynch protocol, however, did not effectively synchronize estrus and ovulation in dairy heifers (35% pregnancy rate compared with 74% in PG controls; Pursley et al., 1997b).

Recently, variations of the Ovsynch protocol (CO-Synch and Select Synch) were tested in postpartum beef cows (Figure 1). It is important to understand that treatment variations of Ovsynch currently being used in postpartum beef cows have not undergone the same validation process that Ovsynch underwent in lactating dairy cows. At this point we do not know whether response in postpartum beef cows to the protocols outlined in Figure 1 is the same or different

from lactating dairy cows due to potential differences in follicular wave patterns. Differences in specific response variables may include: a) the relative length of time to ovulation from the second GnRH injection; b) the anticipated range in timing of ovulation; and c) the degree of ovulation synchrony that occurs.

Two variations from Ovsynch being used most extensively in postpartum beef cows are currently referred to as CO-Synch and Select Synch (Figure 1). CO-Synch (Geary et al., 1998) is similar to Ovsynch in that timing and sequence of injections are the same and all cows are inseminated at a fixed time. CO-Synch differs from Ovsynch, however, in that cows are inseminated when the second GnRH injection is administered, compared to the recommended 16 hours after GnRH for Ovsynch treated cows. Select Synch (Geary et al., 2000) differs too, in that cows do not receive the second injection of GnRH and are not inseminated at a fixed time. Cows synchronized with this protocol are inseminated 12 hours after detected estrus. It is currently recommended for Select Synch treated cows that detection of estrus begin as early as 4 days after GnRH injection and continue through 6 days after PG (Kojima et al., 2000). Select Synch, similar to Ovsynch, was less effective than the melengestrol acetate (MGA)-PG protocol in synchronizing estrus in beef heifers (Stevenson et al., 1999).



**Figure 1.** Methods currently being used to synchronize estrus and ovulation in postpartum beef cows using the GnRH-PG protocol: Ovsynch, CO-Synch and Select Synch.

### MGA-Based Programs

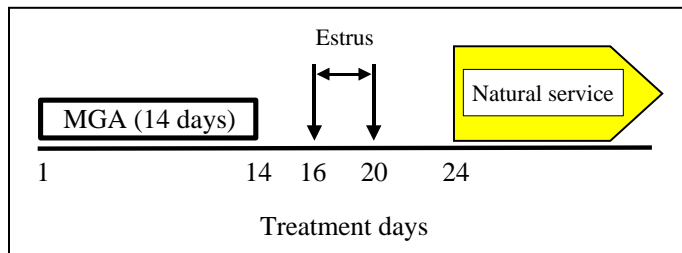
This review includes methods to control estrous cycles of cattle using MGA. Three methods will be outlined for using the MGA program to facilitate estrus synchronization in beef heifers. The choice of which system to use depends largely on a producer's goals. Melengestrol acetate is the common denominator in each of the three systems presented here. Melengestrol acetate is an orally active progestin. When consumed on a daily basis, MGA will suppress estrus and prevent ovulation (Imwalle et al., 2002). Melengestrol acetate may be fed with a grain or a protein carrier and either top-dressed onto other feed or batch mixed with larger quantities of feed. Melengestrol acetate is fed at a rate of 0.5 mg/animal/day in a single daily feeding. The duration of feeding may vary among protocols, but the level of feeding is consistent and critical to success. Animals that fail to consume the required amount of MGA on a daily basis may prematurely return to estrus during the feeding period. This can be expected to reduce the estrous response during the synchronized period. Therefore, adequate bunk space (60 linear

cm/head) must be available so that all animals consume feed simultaneously (Patterson et al., 2003).

Animals should be observed for behavioral signs of estrus each day of the feeding period. This may be done as animals approach the feeding area and before feed distribution. This practice will ensure that all females receive adequate intake. Heifers will exhibit estrus beginning 48 hours after MGA withdrawal, and this will continue for 6 to 7 days. It is generally recommended that females exhibiting estrus during this period not be inseminated or exposed for natural service because of reduced fertility females experience at the first heat after MGA withdrawal.

### Method 1: MGA with Natural Service

The simplest method involves using bulls to breed synchronized groups of females. This practice is useful in helping producers make a transition from natural service to artificial insemination. In this process, heifers receive the normal 14-day feeding period of MGA and are then exposed to fertile bulls about 10 days after MGA withdrawal (Figure 2).



**Figure 2.** MGA and natural service (adapted from Patterson et al., 2000b).

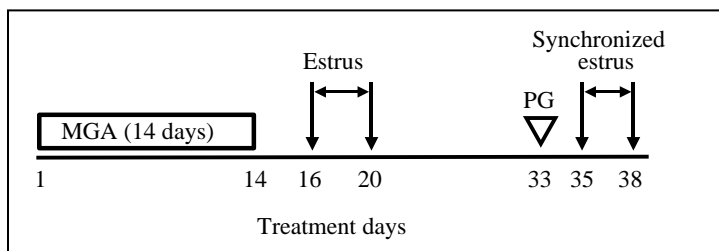
This system works effectively, however careful consideration of bull to female ratios is advised. It is recommended that 15 to 20 synchronized females be exposed per bull. Age and breeding condition of the bull and results of breeding soundness examinations should be considered.

### Method 2: MGA + Prostaglandin

This method of estrus synchronization involves the combination of MGA with prostaglandin  $F_{2\alpha}$ . Prostaglandin  $F_{2\alpha}$  (PG) is a luteolytic compound normally secreted by the uterus of the cow. Prostaglandin  $F_{2\alpha}$  can induce luteal regression but cannot inhibit ovulation. When PG is administered in the presence of a functional corpus luteum (CL) during days 6 to 16 of the estrous cycle, premature regression of the CL begins and the cow returns to estrus.

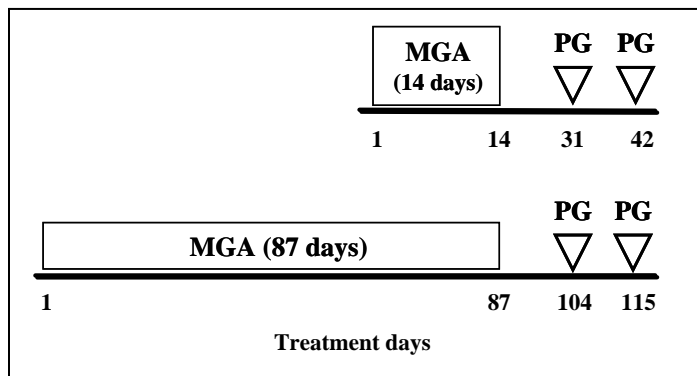
In this program, prostaglandin should be administered 19 days after the last day of MGA feeding. This treatment places all animals in the late luteal stage of the estrous cycle at the time of PG injection, which shortens the synchronized period and maximizes conception rate (Figure 3). Although a 19-day interval is optimal, 17- to 19-day intervals produce acceptable results and provide flexibility for extenuating circumstances (Brown et al., 1988; Deutscher, 2000; Lamb et al., 2000). Five available PG products for synchronization of estrus in cattle can be used after the

MGA treatment: Lutalyse<sup>®</sup>, ProstaMate<sup>®</sup>, InSynch<sup>®</sup>, Estrumate<sup>®</sup>, or estroPLAN<sup>®</sup>. Label-approved dosages differ with each of these products; carefully read and follow directions for proper administration before their use.



**Figure 3.** The MGA-PG protocol (adapted from Brown et al., 1988; Deutscher, 2000; Lamb et al., 2000).

**Management related considerations to long-term feeding of MGA to heifers.** Long-term feeding of MGA to beef heifers and associated effects on fertility may be a concern in specific production systems. It is not uncommon for heifers to be placed on MGA for extended periods of time and subsequently exposed for breeding after placement in backgrounding programs that necessitate long-term MGA administration. Zimbelman et al. (1970) reported no negative effect of either long-term or repeated intervals of feeding MGA to beef heifers and cows, other than the expected reduced conception rate when cattle were bred at the synchronized estrus 3 to 7 days after the last day of MGA feeding. Patterson et al. (1993) designed a study (Figure 4) to compare estrous response and fertility during synchronized estrous periods among beef heifers that were fed MGA for 87 days (long-term, LT) or 14 days (short-term, ST) prior to PG. Heifers were stratified by age and weight to LT- or ST-MGA treatments (Table 1), and received 0.5 mg MGA per head per day for 87 or 14 days, respectively. Heifers in each group were administered PG 17 days after MGA withdrawal. Heifers in both groups that failed to exhibit estrus within 6 days after the first injection of PG, were administered a second injection of PG 11 days later (Figure 4).



**Figure 4.** Comparison of short-term and long-term MGA treatments.

Transrectal ultrasonography was used to examine ovaries of all heifers at the end of treatment with MGA and at the time PG was administered. Heifers that failed to exhibit estrus after the first injection of PG were re-examined prior to the second PG injection. All heifers were exposed for natural-service for an additional 45 d after the AI period. More ST-treated heifers exhibited estrus after the first injection of PG than LT-treated heifers (Table 2;  $P < 0.05$ ). Total response after the two injections of PG, however, did not differ between treatments.



Furthermore, there were no significant differences between treatments in synchronized conception or pregnancy rates, or pregnancy rates at the end of the breeding period (Table 3). A higher incidence of luteinized follicular cysts (Table 3) was observed among heifers in the LT-treatment compared with heifers in the ST-treatment [LT, 11/30 (37%); ST, 0/31 (0%)]. This observation may explain differences in estrous response between treatments following the first injection of PG. These data indicate that long-term feeding of MGA may result in a higher than normal incidence of luteinized follicular cysts and an associated reduction in estrous response after PG. The data indicate, however, that re-injection with PG resulted in satisfactory breeding performance among heifers that were fed MGA for extended periods of time.

**Table 1.** Ages and weights of heifers at the time PG was administered.

Treatment	No. of heifers	Age, d	Weight, lb
Short-term, 14 d	31	427	865
Long-term, 87 d	30	423	851

<sup>1</sup>Adapted from Patterson et al., 2003.

**Table 2.** Estrous response and fertility of heifers treated long-term or short-term with MGA.

Response variable	Short-term MGA, 14 d			Long-term MGA, 87 d		
	1 <sup>st</sup> PG <sup>a</sup>	2 <sup>nd</sup> PG <sup>a</sup>	Total	1 <sup>st</sup> PG <sup>a</sup>	2 <sup>nd</sup> PG <sup>a</sup>	Total
Estrous response	24/31 (77% <sup>b</sup> )	4/7 (57%)	28/31 (90%)	16/30 (53% <sup>c</sup> )	10/14 (71%)	26/30 (87%)
Synchronized conception	15/24 (63%)	3/4 (75%)	18/28 (64%)	12/16 (75%)	6/10 (60%)	18/26 (69%)
Synchronized pregnancy	-----	-----	18/31 (58%)	-----	-----	18/30 (60%)
Final pregnancy	-----	-----	28/31 (90%)	-----	-----	27/30 (90%)

<sup>a</sup>1<sup>st</sup> PG refers to animals that responded to PG administered 17 days after MGA withdrawal. 2<sup>nd</sup> PG refers to animals that failed to respond to the first injection of PG that were reinjected 11 days later.

<sup>b, c</sup>Percentages within row and between treatments with unlike superscripts differ (P < 0.05; Adapted from Patterson et al., 2003).

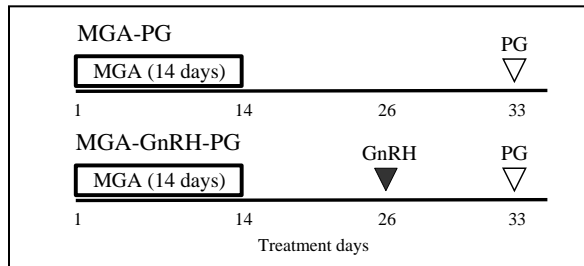
**Table 3.** Ovarian morphology of heifers treated long-term or short-term with MGA.

Treatment	Normal		Abnormal <sup>a</sup>	
Short-term	31/31	(100%)	0/31	(0%)
Long-term	19/30	(63%)	11/30	(37%)

<sup>a</sup>Abnormal = presence of luteinized follicular cysts, 20-45 mm diameter (Adapted from Patterson et al., 2003).

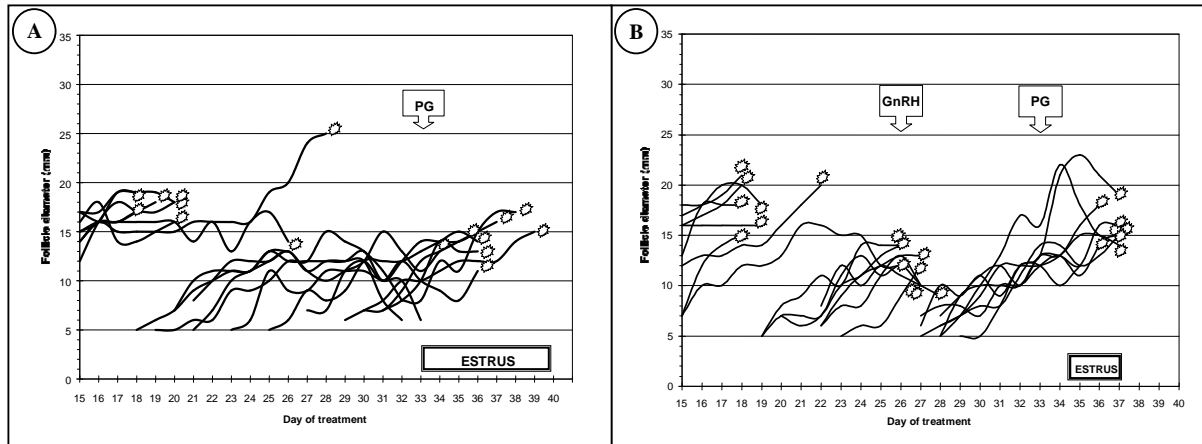
### Method 3: MGA<sup>®</sup> Select

Studies with heifers showed that both synchrony of estrus and total estrous response were improved when PG is administered 19 days after MGA withdrawal compared with those of heifers injected on day 17 after MGA withdrawal (Deutscher et al., 2000; Lamb et al., 2000). We evaluated a modified MGA-PG protocol for inducing and synchronizing a fertile estrus in beef heifers (Wood et al., 2001; Figure 6). The first modification changed the day of PG injection from day 31 to day 33 of treatment. The second modification was the addition of GnRH on day 26 of treatment. We found that the addition of GnRH on day 26 of the MGA-PG protocol induced luteal tissue formation and initiated a new follicular wave on approximately day 28 in cycling beef heifers (Figure 7B). The proportion of heifers with synchronized follicular waves on day 33 was increased significantly compared to heifers that did not receive GnRH (Wood et al., 2001; Figure 7A and 7B).

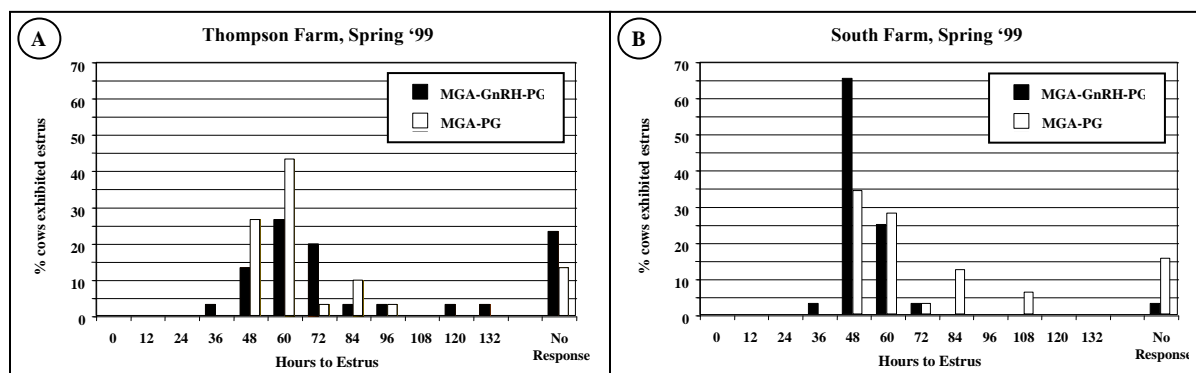


**Figure 6.** A modified long-term MGA protocol. Heifers were fed MGA for 14 days; 19 days after MGA withdrawal PG was administered to all heifers. GnRH was administered to ½ of the heifers 7 days prior to PG (Wood et al., 2001).

Wood-Follis et al. (2004) reported differences in estrous response and synchrony of estrus during the synchronized period among heifers assigned to the treatments illustrated in Figure 6. This difference in estrous response and degree of synchrony was based on the percentage of heifers that were pubertal at the time treatment with MGA began. Figures 8A and 8B illustrate these differences (Wood-Follis et al., 2004). Figure 8A shows the distribution of estrus where only 30% of the heifers were pubertal at the time treatment with MGA began, whereas Figure 8B illustrates the distribution of estrus for heifers where 56% of the heifers were pubertal at the same time. The increased degree of estrous cyclicity of heifers shown in Figure 8B was associated with a reduced variance in the interval to estrus among MGA-GnRH-PG treated heifers. AI pregnancy rates remained high for both MGA-GnRH-PG and MGA-PG treated heifers and were not different (67% and 60%, respectively [Figure 8A] and 75% and 72%, respectively [Figure 8B]).



**Figure 7A and 7B.** Patterns of dominant follicle development in control (MGA-PG; A) and GnRH treated (MGA-GnRH- PG; B) heifers. Administration of GnRH (B) caused the synchronized development of a dominant follicle before PG injection. Follicular development in MGA-PG treated heifers was poorly synchronized (Wood et al., 2001).



**Figure 8A and 8B.** Percentage of heifers observed in estrus for MGA-PG and MGA-GnRH-PG treated heifers. Estrous cyclicity rates were 30% and 56% for heifers at Location 1 (A) and 2 (B), respectively, at the time treatment with MGA began (Wood-Follis et al., 2004).

**Additional considerations.** An additional consideration for Methods 2 and 3 (MGA-PG and MGA Select) pertains to heifers that fail to exhibit estrus after the last PG injection. In this case, non-responders may be re-injected with PG 11 to 14 days after the last injection of PG was administered. These females would then be observed for signs of behavioral estrus for an additional 6 to 7 days. This procedure would maximize efforts to inseminate as many females within the first 2 weeks of the breeding period as possible. Females that were inseminated during the first synchronized period should not be re-injected with PG. In addition, the decision to use Method 3 in heifers should be based on careful consideration of the heifer's age, weight, and pubertal status (Federal Register, 1997; Patterson et al., 1989; Wood-Follis et al., 2004; Zimelman, 1963; Zimelman and Smith, 1966).

## Development of the 7-Day CIDR-PG Protocol for Heifers

Lucy et al., (2001; Table 4) summarized results from initial studies conducted in the U.S. involving CIDR-based protocols for use in synchronizing estrus in beef heifers. These data were submitted to FDA in support of the original approval for the CIDR in beef heifers and cows. Three treatments were involved in the study and included: 1) an untreated control; 2) PG only; and 3) 7-day CIDR-PG. The 7-day CIDR-PG treated heifers had CIDRs inserted for 7 days with PG administered on day 6 of CIDR treatment. The 7-day CIDR-PG protocol yielded greater pregnancy rates compared with control or PG treated heifers. Treatment with CIDR increased synchronization rates within the first 3 d following PG, resulting in enhanced pregnancy rates. The improved pregnancy rate in prepubertal beef heifers treated with the CIDR was noteworthy because prepubertal heifers in the control or PG treatments never attained pregnancy rates that were similar to those of the 7-day CIDR-PG treated heifers. The drawback of the protocol was that PG was administered on d 6 after CIDR insertion, which required an additional day of handling the heifers.

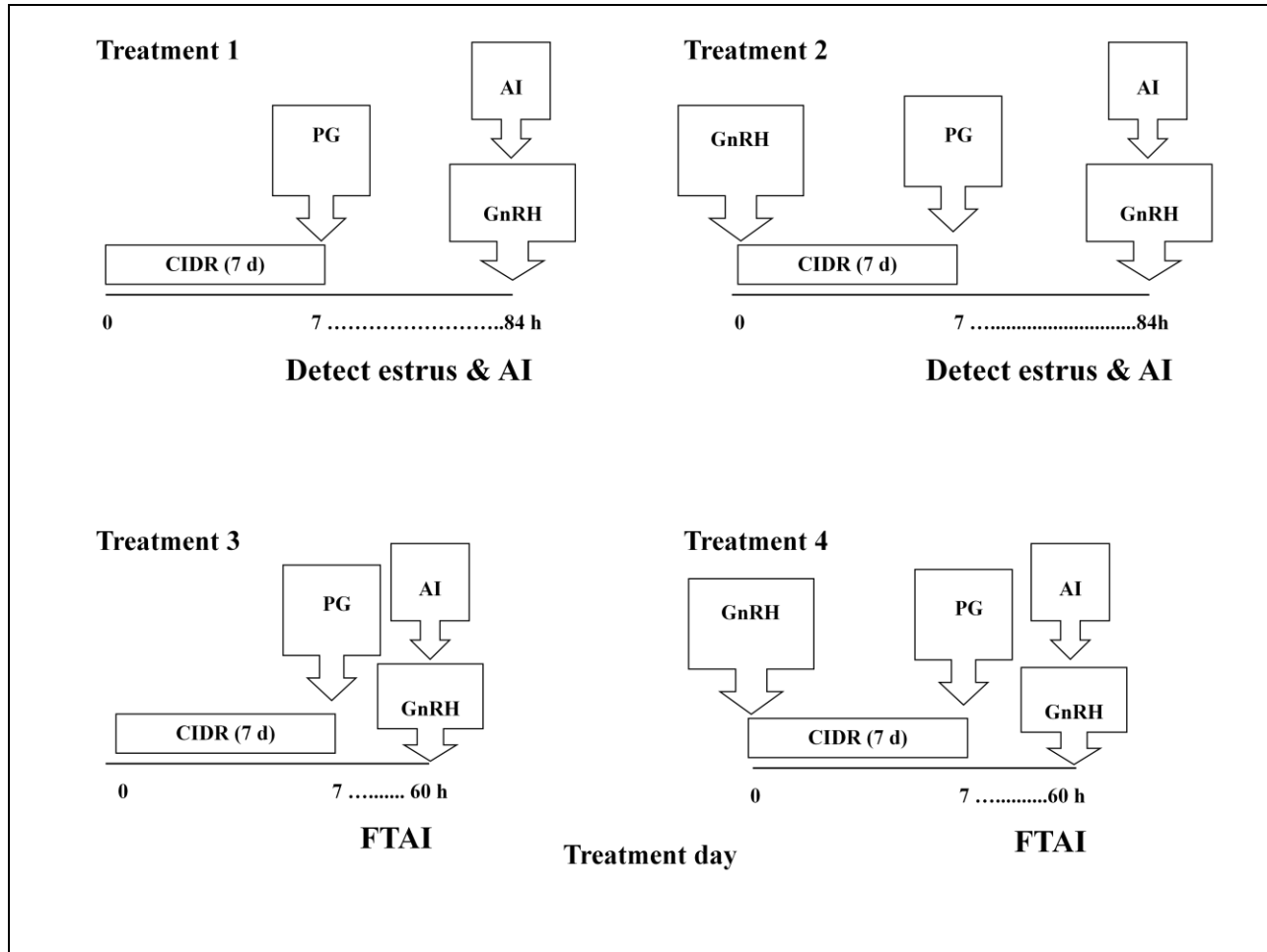
**Table 4.** Synchronization, conception, and pregnancy rate for beef heifers (modified from Lucy et al., 2001).

Item	Synchronization rate		Conception rate		Pregnancy rate	
	No.	%	No.	%	No.	%
Prepubertal						
Control	8/107	7	6/8	75	6/7	6
PG	11/101	11	6/11	50	6/101	6
CIDR-PG	50/105	48	29/50	58	29/105	28
Cyclic						
Control	25/44	17	13/25	52	13/144	9
PG	56/151	37	29/56	52	29/151	19
CIDR-PG	93/116	80	57/93	61	57/116	49
Total						
Control	33/151	22	19/33	58	19/151	13
PG	67/252	27	35/67	52	35/252	14
CIDR-PG	143/221	65	86/143	60	86/221	39

## The Multi-State CIDR Trial

Lamb et al. (2006) lead a multi-state effort involving 12 locations in 6 states to determine whether: 1) administration of an estrus synchronization protocol followed by fixed-time AI could yield pregnancy rates similar to a protocol requiring detection of estrus; and 2) whether an injection of GnRH at CIDR insertion enhanced pregnancy rates in beef heifers. Four treatments were involved in the study (Figure 9). Heifers in treatment 1 were observed for signs of behavioral estrus and inseminated on the basis of observed estrus up through 72 h after PG. Eighty four hours following the administration of PG all heifers that failed to exhibit estrus to that point were inseminated by appointment with GnRH administered at AI. Heifers in treatment 2 were handled in the same way as heifers in treatment 1, however all heifers in treatment 2 received an injection of GnRH at CIDR insertion. Heifers in treatments 3 and 4 received the

same treatment schedules as heifers in treatments 1 and 2, respectively however heifers in both treatments 3 and 4 were inseminated by appointment 60 hours after PG with GnRH administered at AI. Although no differences in pregnancy rates were detected among treatments, heifers that were inseminated in the estrus-detection treatments had numerically higher pregnancy rates than heifers in the fixed-time AI treatments (Table 5).



**Figure 9.** Treatment schedules for heifers in the multi-state CIDR trial (Lamb et al., 2006).

**Table 5.** Pregnancy rates following AI among beef heifers in the multi-state CIDR trial (Lamb et al, 2006).<sup>1</sup>

Item	Treatments							
	<u>1</u>		<u>2</u>		<u>3</u>		<u>4</u>	
	No.	%	No.	%	No.	%	No.	%
Prepubertal	19/36	53	32/54	59	22/36	61	28/44	64
Cycling	195/341	57	201/317	63	189/353	54	185/346	54

<sup>1</sup>Refer to Figure 9 for a description of the 4 treatment protocols.

## How Do MGA- and CIDR-Based Protocols Compare?

*Substituting EAZI-BREED CIDR inserts for MGA in the MGA Select protocol in beef heifers.* There have been increasing numbers of reports (Missouri Show-Me-Select Replacement Heifer Program) that pregnancy rates resulting from MGA-based estrus synchronization protocols have declined in yearling age heifers (Utter and Corah, 1994). These instances of reduced fertility are generally associated with heifers in which estrous cyclicity rates are high, and the heifers are generally heavier weight and in higher body condition prior to treatment with MGA compared to lighter weight, lower conditioned heifers.

We designed a study (Kojima et al., 2004) to compare long-term progestin-based estrus synchronization protocols in beef heifers. Presynchronization with MGA (MGA Select) or CIDRs (14 day treatment with MGA or CIDR, followed 12 or 9 d later, respectively, with an injection of GnRH, and PG 7 d after GnRH) was compared on the basis of estrous response, timing of AI, and pregnancy rate in beef heifers. No differences in estrous response were detected between MGA Select and 14-d CIDR treated heifers; however, 14-d CIDR treated heifers showed an improvement in synchrony of estrus, conception, and pregnancy rates during the synchronized period. These improvements associated with a 14-d CIDR treatment were attributed to a reduced interval to estrus (Macmillian and Peterson, 1993) and improved synchronization of follicular waves after CIDR removal as compared to the end of MGA feeding.

A widely held hypothesis is that GnRH is less effective at synchronizing follicular waves in heifers compared to cows. Lamb et al. (2006) reported no difference in synchrony of estrus or pregnancy rate between CIDR + PG and Select Synch + CIDR treated heifers, suggesting that response to GnRH in heifers at CIDR insertion may be of limited value. Recently, Atkins et al. (2008; Table 6) evaluated follicular response to GnRH among pubertal beef heifers on specific days of the estrous cycle. Response was based on ovulation or luteinization of a dominant follicle and subsequent initiation of a new follicular wave in response to GnRH. These data (Table 6) support the concept that presynchronization prior to initiation of the GnRH + PG protocol may be of greater importance in heifers, and therefore significant in relation to success we initially reported with the long-term CIDR-GnRH-PG protocol (Kojima et al., 2004).

**Table 6.** Response to GnRH in estrous cycling beef heifers based on the day of the estrous cycle GnRH was administered (From Atkins et al., 2008).

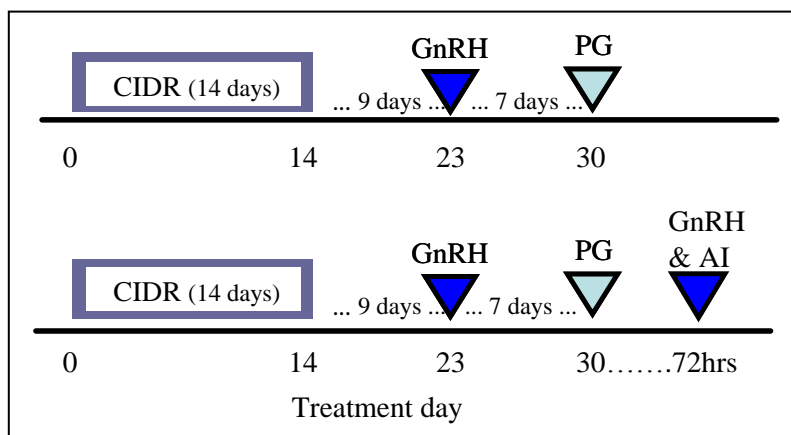
Day of treatment	1 <sup>st</sup> GnRH (no. & % responding)	2 <sup>nd</sup> GnRH (no. & % responding)
Day 2	0/7 = 0%	3/7 = 43%
Day 5	8/8 = 100%	8/8 = 100%
Day 10	0/6 = 0%	5/6 = 83%
Day 15	5/8 = 63%	1/8 = 13%
Day 18	5/8 = 63%	2/8 = 25%

Schafer et al. (2006) characterized follicular dynamics, timing of estrus, and response to GnRH in yearling beef heifers after treatment with the 14-day CIDR protocol. The objective of the

experiment was to characterize response after treatment with a 14-day CIDR insert followed by the administration of GnRH and PG in 79 Angus crossbred heifers. At the initiation of the experiment 53 heifers were estrous cycling and 26 were prepubertal based on two blood samples for progesterone collected 10 days and 1 day prior to initiation of treatment. CIDRs were inserted into all heifers on the same day for 14 days, GnRH was injected on day 23, and PG on day 30. Estrus detection was performed continuously after CIDR removal using the HeatWatch<sup>®</sup> Estrus Detection System. The study characterized estrous response and timing of estrus after treatment with the 14-day CIDR, follicular dynamics the day preceding and the day GnRH was administered, response to GnRH, and timing of estrus after PG. Sixty-nine heifers exhibited estrus (47 pubertal, 22 prepubertal) after CIDR removal.

There was no difference ( $P > 0.05$ ) in the interval to estrus after CIDR removal for pubertal and prepubertal heifers [ $50.0 \pm 27.3$  pubertal, and  $48.1 \pm 28.3$  h prepubertal, respectively]. Follicular dynamics were recorded for all heifers the day preceding GnRH, the day GnRH was administered, and resulting response to GnRH. Comparisons were made on the basis of the day of the estrous cycle heifers were on at the time GnRH was administered based on the day estrus was expressed after CIDR removal. There was a significant effect ( $P < 0.05$ ) of day of the estrous cycle on mean follicle diameter at the time GnRH was administered. Response to GnRH was highest among heifers with dominant follicles  $\geq 10.0$  mm (64/71, 90%) and lower among heifers with follicles  $< 10$  mm (4/8, 44%). Mean follicle diameter was  $\geq 10.0$  mm among all heifers that were on d 5, 6, 7 or 8 of the estrous cycle at the time GnRH was administered. Concentrations of progesterone in serum at PG were higher among pubertal versus prepubertal heifers [7.9 pubertal versus 6.9 ng/ml prepubertal, respectively). Estrous response after PG did not differ among pubertal and prepubertal heifers and peaked between 48 and 60 hours. The study provided a descriptive comparison of response to presynchronization with a CIDR prior to GnRH and PG in pubertal and prepubertal beef heifers.

We used this protocol successfully in conjunction with either heat detection and AI (Leitman et al., 2008) or FTAI with AI performed 72 hours after PG and GnRH administered at the time of AI (Busch et al., 2007; Figure 10). On-farm field trials are summarized in Table 7 reporting results after use of the CIDR Select protocol in conjunction with breeding programs requiring heat detection or fixed-time AI. It is interesting to note that pregnancy rates following administration of the CIDR Select protocol were comparable whether heifers were inseminated on the basis of observed estrus (Table 7) or at predetermined fixed times (Table 7).



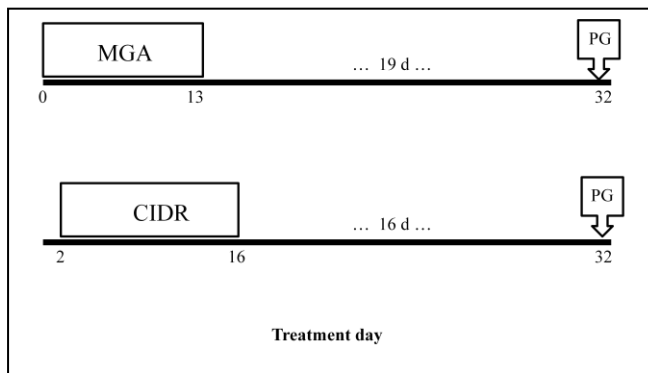
**Figure 10.** Estrus synchronization schedules involving use of the CIDR Select protocol in breeding programs for beef heifers that require heat detection or fixed-time AI.

**Table 7.** Pregnancy rates after administration of the CIDR Select protocol in field trials involving AI performed after observed estrus or fixed-time AI performed 72 hours after PG (Patterson et al., 2006).

Breeding program	No. pregnant	No. inseminated	Pregnancy rate (%)
Estrus detection & AI	499	830	60
Fixed-time AI	518	853	61

Tauk et al. (2007) compared CIDR-PG and MGA-PG protocols in beef heifers. The study was designed to compare: 1) estrous synchronization response following progestin removal, and PG administered 17 or 19 days after progestin withdrawal, and b) AI pregnancy rates during the synchronized period. More ( $P < 0.05$ ) CIDR-treated heifers exhibited estrus within 120 h after progestin removal than MGA-treated heifers. Intervals to estrus after progestin removal were shorter ( $P < 0.05$ ) for CIDR-treated heifers than MGA-treated heifers and more ( $P < 0.05$ ) CIDR-treated heifers exhibited estrus and were inseminated within 60 h after PG than MGA-treated heifers. Pregnancy rates did not differ between MGA-treated (66%) and CIDR-treated heifers (62%). Tauk et al. (2007) concluded that use of CIDR as a progestin source was equally effective as MGA in synchronizing estrus in beef heifers.

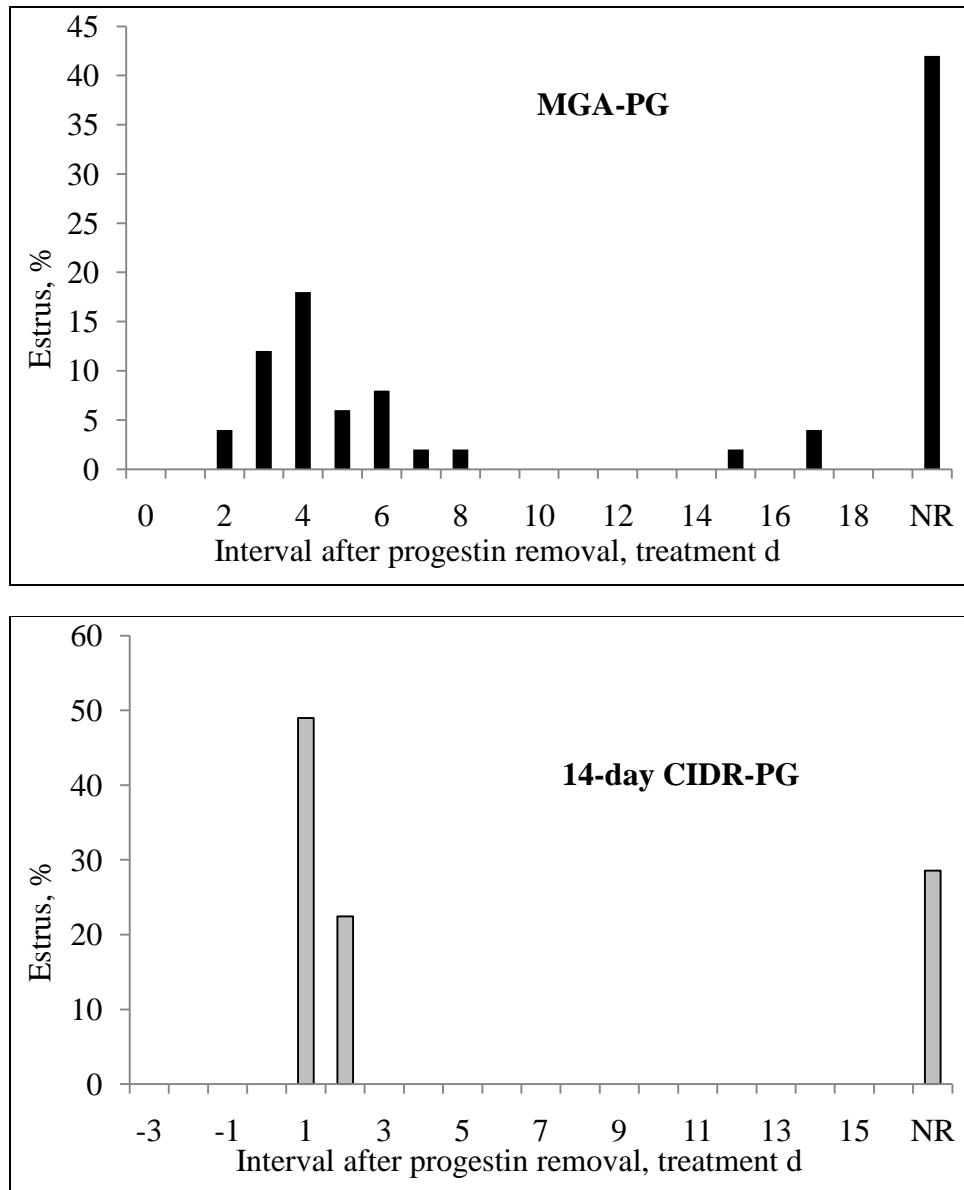
More recently, Mallory et al. (2010) conducted two experiments to evaluate long-term MGA and CIDR-based estrus synchronization protocols on the basis of potential for use in facilitating FTAI in estrous cycling and prepubertal beef heifers. Heifers in the first experiment (Figure 11) were fitted with HeatWatch estrus detection transmitters at the time of progestin removal for continuous estrus detection, and in both experiments the synchronized period was designated as 0 to 144 h following PG. HeatWatch transmitters were maintained on all heifers until AI was performed.



**Figure 11.** Treatment schedule for heifers assigned to the MGA-PG and 14-day CIDR-PG treatment protocols. Heifers assigned to MGA-PG received MGA in a 1.0-kg feed supplement for 14 d and were administered PG on d 32. Heifers assigned to 14-d CIDR-PG received a CIDR insert from d 2 of treatment to d 16, and PG on d 32 (Mallory et al., 2010).



Figure 12 illustrates the pattern of estrus distribution following withdrawal of MGA from feed or removal of CIDR for the respective treatments. The variance associated with interval to estrus after progestin withdrawal/removal was significantly reduced ( $P < 0.01$ ) among 14-day CIDR-PG compared to MGA-PG treated heifers.



**Figure 12.** Percentage of heifers in MGA-PG and 14-day CIDR-PG treatments that exhibited estrus after withdrawal/removal of progestin: MGA-PG (black bar) and 14-day CIDR-PG (gray bar). NR = no estrous response. Heifers assigned to MGA-PG received MGA in a 1.0-kg feed supplement for 14 d and were administered PG on d 32. Heifers assigned to 14-day CIDR-PG received a CIDR insert from d 2 of treatment to d 16, and PG on d 32 (Mallory et al., 2010).

Estrous response after PG was greater ( $P = 0.01$ ) for 14-day CIDR-PG (92%) than for MGA-PG (85%) treated heifers (Table 8). The distribution of estrus after PG is depicted in Figure 13. The mean interval to estrus after PG did not differ ( $P = 0.73$ ) between MGA-PG ( $57.4 \pm 2.5$  h) and 14-day CIDR-PG ( $56.2 \pm 2.5$  h) treated heifers (Table 9). There was however, a significant difference in the mean interval to estrus after PG ( $P = 0.04$ ) between estrous cycling ( $62.4 \pm 2.4$  h) and prepubertal heifers ( $52.4 \pm 4.4$  h) assigned to the MGA-PG protocol, but no difference ( $P = 0.75$ ) between estrous cycling and prepubertal heifers assigned to 14-day CIDR-PG ( $55.4 \pm 2.4$  h and  $57.0 \pm 4.4$  h, respectively).

The variance associated with interval to estrus after PG was reduced ( $P < 0.01$ ) among 14-day CIDR-PG heifers than for MGA-PG treated heifers. Variance for interval to estrus after PG differed between treatments for estrous cycling ( $P < 0.01$ ) and prepubertal ( $P < 0.05$ ) heifers; however, variance for interval to estrus after PG did not differ within treatment ( $P > 0.10$ ) for estrous cycling and prepubertal heifers (Table 9).

**Table 8.** Estrous response for estrous cycling and prepubertal heifers assigned to MGA-PG or 14-day CIDR-PG<sup>1</sup> treatment protocols (Mallory et al., 2010).

Item	MGA-PG	14-day CIDR-PG
Estrous response after PGF <sub>2α</sub>		
Proportion	170/200	180/196
Percent	85 <sup>a</sup>	92 <sup>b</sup>
Estrous cycling		
Proportion	135/154	138/151
Percent	88 <sup>x</sup>	91
Prepubertal		
Proportion	35/46	42/45
Percent	76 <sup>c,y</sup>	93 <sup>d</sup>

<sup>a,b</sup>Means within rows with different superscripts are different ( $P = 0.01$ ).

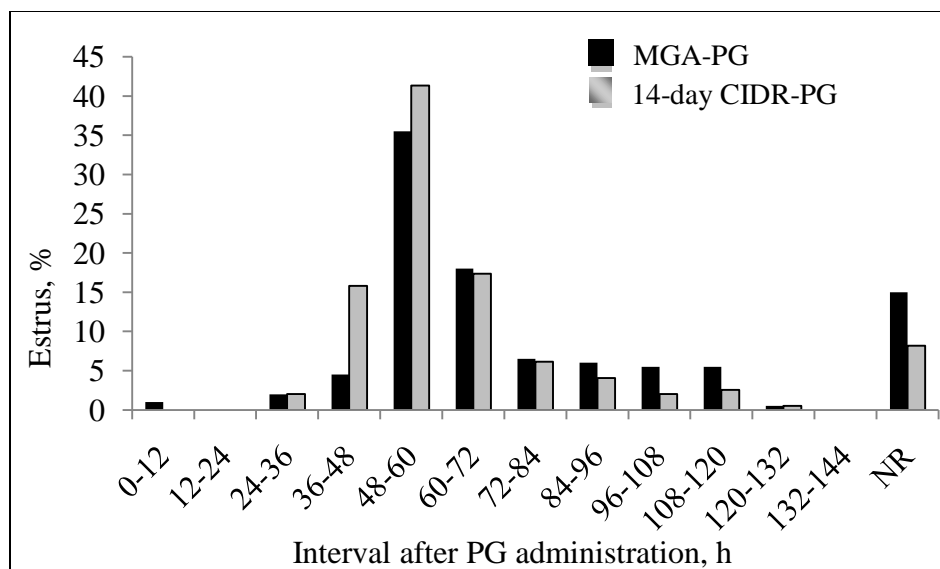
<sup>c,d</sup>Means within rows with different superscripts are different ( $P = 0.03$ ).

<sup>x,y</sup>Means within columns with different superscripts tend to differ ( $P = 0.06$ ).

<sup>1</sup>See Figure 11 for a description of the treatment protocols.

<sup>2</sup>Estrous cycling = heifers assigned a RTS of 4 or 5.

<sup>3</sup>Prepubertal = heifers assigned a RTS of 2 or 3.



**Figure 13.** Percentage of heifers in MGA-PG and 14 day CIDR-PG treatments that exhibited estrus after PG: MGA-PG (black bar) and 14-day CIDR-PG (gray bar). NR = no estrous response. Heifers assigned to MGA-PG received MGA in a 1.0-kg feed supplement for 14 d and were administered PG on d 32. Heifers assigned to 14-day CIDR-PG received CIDR insert from d 2 of treatment to d 16, and PG on d 32 (Mallory et al., 2010).

**Table 9.** Mean and variance for interval from PG to estrus for estrous cycling and prepubertal heifers assigned to MGA-PG or 14-day CIDR-PG treatment protocols (See Figure 11 for a description of the treatment protocols; Mallory et al., 2010).

Item	MGA-PG	14-day CIDR-PG
Interval from PGF <sub>2α</sub> to estrus, h (LS mean ± SE)		
Estrous cycling	57.4 ± 2.5	56.2 ± 2.5
Prepubertal	62.4 ± 2.4 <sup>a,x</sup>	55.4 ± 2.4 <sup>b</sup>
Variance for interval to estrus after PGF <sub>2α</sub>		
Estrous cycling	52.4 ± 4.4 <sup>y</sup>	57.0 ± 4.4
Prepubertal	466 <sup>c</sup>	282 <sup>d</sup>
Estrous cycling	432 <sup>c</sup>	272 <sup>d</sup>
Prepubertal	615 <sup>e</sup>	316 <sup>f</sup>

<sup>a,b</sup> Means within rows with different superscripts are different ( $P = 0.04$ ).

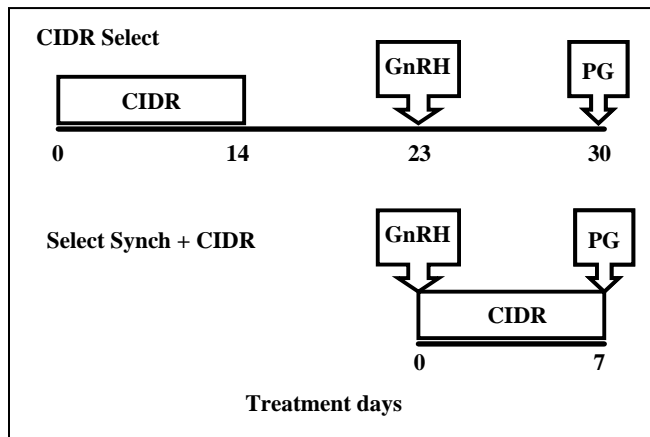
<sup>c,d</sup> Variances within rows with different superscripts are different ( $P < 0.01$ )

<sup>e,f</sup> Variances within rows with different superscripts are different ( $P < 0.05$ )

<sup>x,y</sup> Means within columns with different superscripts are different ( $P = 0.04$ ).

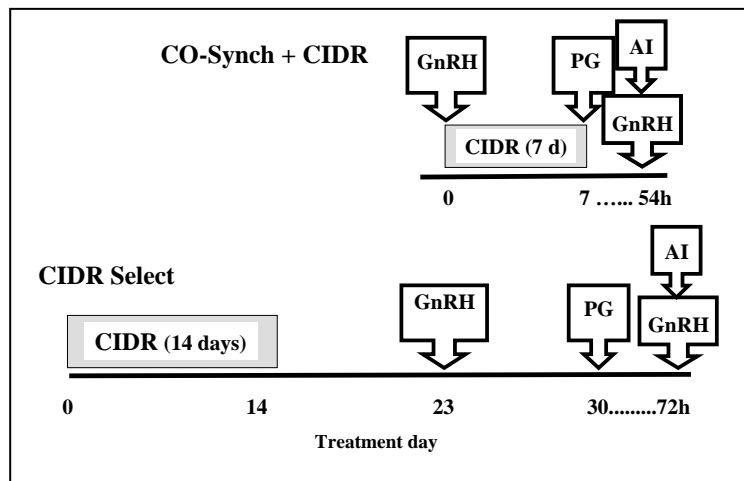
## How Do Short- and Long-term CIDR-Based Protocols Compare in Synchronizing Ovulation Prior to Fixed-Time AI in Beef Heifers?

Leitman et al. (2008) reported an improvement in synchrony of estrus and ovulation among CIDR Select treated heifers in comparison to Select Synch + CIDR treated contemporaries (Figure 14). There was more variance associated with the interval from PG to estrus ( $P < 0.06$ ) and ovulation ( $P < 0.05$ ) between prepubertal and estrous cycling heifers synchronized with the Select Synch + CIDR protocol compared to CIDR Select (Leitman et al., 2008). These data (Leitman et al., 2008) suggested that the CIDR Select protocol may facilitate FTAI more effectively in mixed groups of prepubertal and estrous cycling beef heifers compared with Select Synch + CIDR.



**Figure 14.** Comparison of CIDR Select and Select Synch + CIDR protocols (Leitman et al., 2008)

Busch et al. (2007) compared pregnancy rates resulting from fixed-time AI (FTAI) following administration of either one of two controlled internal drug release (CIDR)-based protocols (Figure 15). Heifers at three locations were assigned to one of two treatments within reproductive tract scores (RTS; 1 to 5, 1 = immature, and 5 = cycling) by age and weight. Heifers assigned to CIDR Select received a CIDR insert from d 0 to 14 followed by GnRH 9 d after CIDR removal and PG 7 d after GnRH treatment. Heifers assigned to CO-Synch + CIDR were administered GnRH and received a CIDR insert, and PG and CIDR removal 7 d later (Figure 15).



**Figure 15.** Treatment schedule for heifers assigned to the CIDR Select and CO-Synch + CIDR protocols (Busch et al., 2007).

Artificial insemination was performed at predetermined fixed-times for heifers in both treatments at 72 or 54 h after PG for the CIDR Select and CO-Synch + CIDR groups, respectively. All heifers were administered GnRH at the time of insemination. Fixed-time AI pregnancy rates (Table 10) were significantly greater ( $P = 0.02$ ) following the CIDR Select protocol (62%) compared to the CO-Synch + CIDR protocol (47%). In summary, the CIDR Select protocol resulted in a greater and more synchronous estrous response and significantly greater fixed-time AI pregnancy rates compared to the CO-Synch + CIDR protocol (Busch et al., 2007).

**Table 10.** Pregnancy rates of heifers in response to fixed-time AI and at the end of the breeding season (means  $\pm$  SE; Busch et al., 2007).

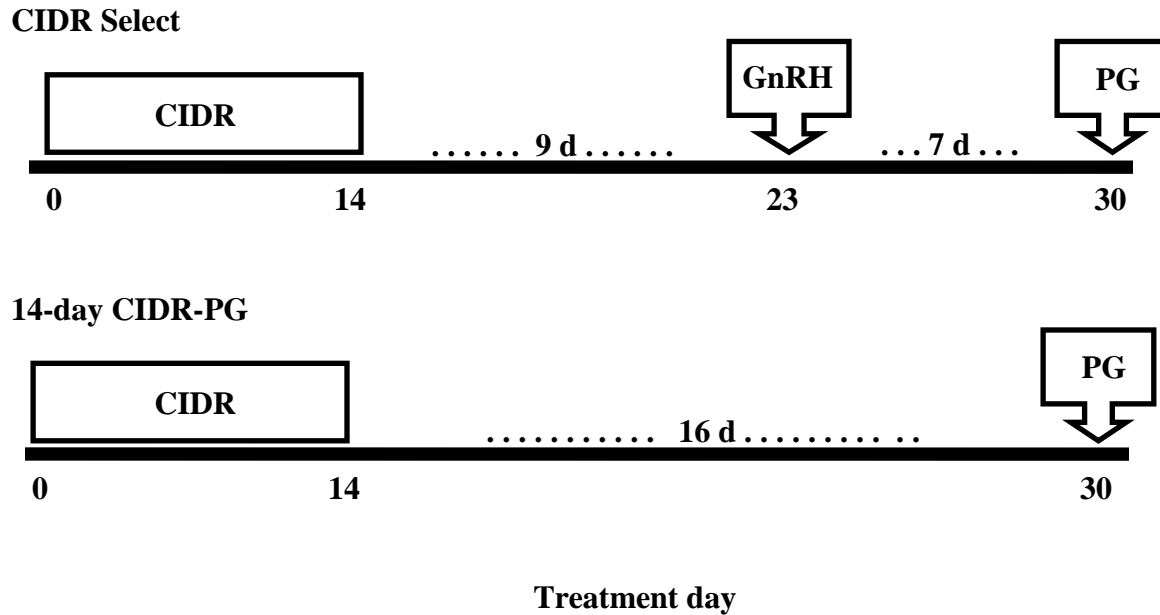
Item	Pregnancy rate to fixed-time AI		Pregnancy rate at end of breeding season	
	Proportion	%	Proportion	%
CIDR Select	67/108	62 <sup>x</sup>	97/108	90
CO-Synch + CIDR	51/109	47 <sup>y</sup>	99/109	91

<sup>x,y</sup>Means within a column with different superscripts are different,  $P < 0.05$ .

### How Do the CIDR Select (CIDR-GnRH-PG) and 14-day CIDR-PG Treatment Protocols Compare?

Recent studies, questioned the utility of gonadotropin releasing hormone (GnRH) in estrus synchronization protocols for beef heifers (Wood-Follis et al., 2004; Lamb et al., 2006; Leitman et al., 2009a, b). Administration of GnRH at the beginning of an estrus synchronization protocol in beef heifers failed to demonstrate an increase in pregnancy rates resulting from fixed-time AI; however, the standard deviation of pregnancy rates was increased when GnRH was not included. These data suggest that incorporation of GnRH in a FTAI protocol may increase the uniformity of pregnancy rates in beef heifers across locations compared to protocols based on estrus detection alone (Lamb et al., 2006).

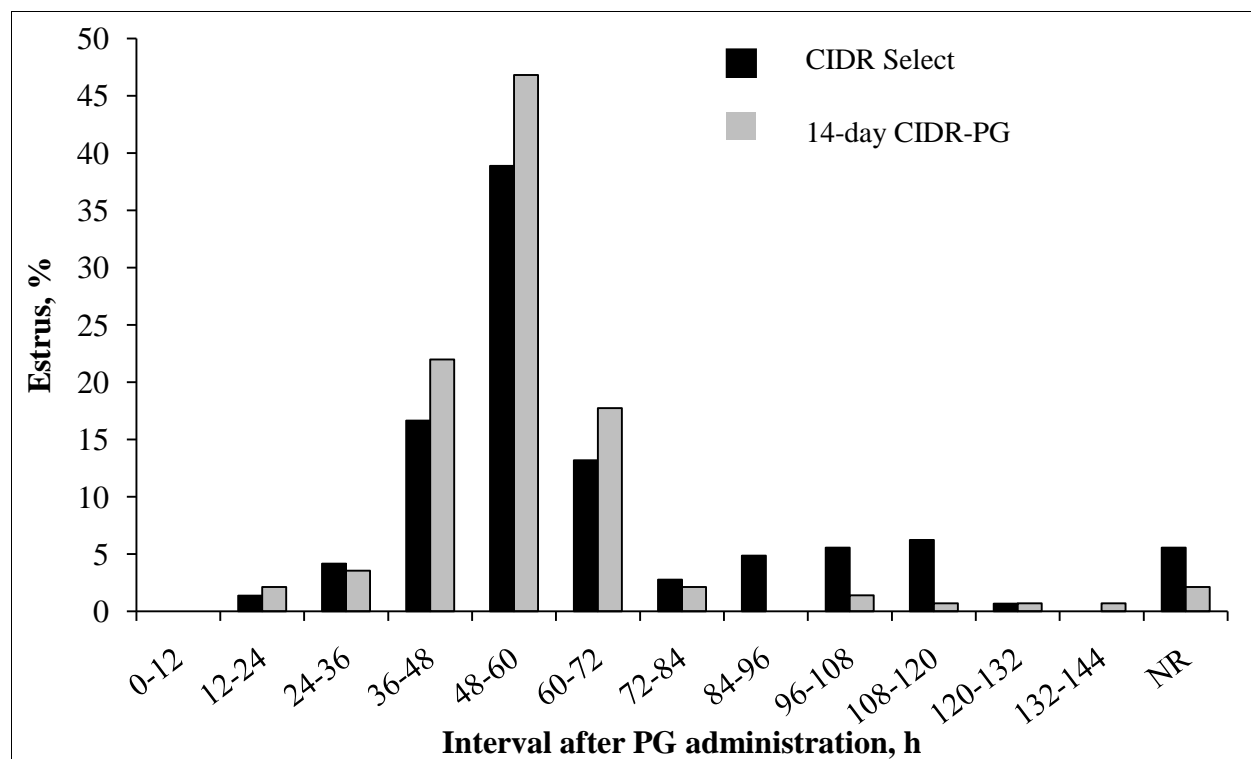
Leitman et al. (2009b; Figure 16) compared the CIDR Select and 14-day CIDR-PG protocols to determine the necessity of adding a GnRH injection for synchronization of estrus in beef heifers that were prepubertal or estrous cycling at the initiation of treatment. Treatments were compared on the basis of estrous response and distribution of estrus after PG, and of synchronized AI conception and pregnancy rates.



**Figure 16.** Treatment schedule for heifers assigned to the CIDR Select and 14-day CIDR-PG protocols. Heifers assigned to CIDR Select received a CIDR insert from d 0 to 14, GnRH on d 23, and PG on d 30. Heifers assigned to 14-day CIDR-PG received a CIDR insert from d 0 to 14, and PG on d 30 (Leitman et al., 2009b).

Figure 17 illustrates differences in estrous response after PG between treatments. In this experiment (Figure 16; Leitman et al., 2009b), differences in the variance for interval to estrus were detected based on the main effects of treatment and estrous cyclicity status as well as their interaction. Heifers assigned to the CIDR-PG protocol had a more highly synchronized estrus compared to heifers assigned to the CIDR Select protocol; and regardless of treatment, the prepubertal heifers had a more highly synchronized estrus compared to the estrous-cycling heifers. Improved synchrony of estrus observed among prepubertal heifers may be a result of a more highly synchronized estrous response following CIDR removal compared to estrous cycling heifers. Stage of cycle differences among estrous cycling heifers at CIDR insertion would perhaps explain the potential for reduced synchrony of estrus following CIDR removal compared to the prepubertal heifers. Both the estrous-cycling and prepubertal heifers assigned to the CIDR-PG protocol had a more highly synchronized estrus compared to their counterparts assigned to the CIDR Select protocol. While the synchrony of estrus was similar between the estrous-cycling and prepubertal heifers assigned to the CIDR Select protocol, prepubertal heifers assigned to the CIDR-PG protocol had a more highly synchronized estrus compared to estrous-cycling heifers assigned to the CIDR-PG protocol.

We know from previous studies that there is no difference in estrous response following CIDR removal when comparing estrous-cycling or prepubertal heifers treated with a 14-d CIDR protocol (Leitman et al., 2008). Although the mean interval to estrus following CIDR removal was shorter for estrous-cycling heifers compared to prepubertal heifers, there was no difference



**Figure 17.** Percentage of heifers in the CIDR Select and 14-day CIDR-PG treatments that exhibited estrus after PG: CIDR Select (black bar) and 14-day CIDR-PG (gray bar). NR = no estrous response. See Figure 16 for a description of the treatment protocols (Leitman et al., 2009b).

in the variance for interval to estrus. Leitman et al. (2008) hypothesized that presynchronization with a progestin before GnRH and PG would be more effective in synchronizing estrus compared with 7-d CIDR-based or GnRH-PG estrus synchronization protocols. This hypothesis was tested and accepted. The study (Leitman et al., 2008) also revealed that estrous response and synchrony of estrus following removal of the CIDR after treatment for 14 days was similar between estrous cycling and prepubertal heifers. Additionally, over 88% of the heifers (estrous-cycling and prepubertal) were on d 7 or 8 of their estrous cycles 9 d following CIDR removal, coincident with the time at which GnRH was administered on d 23 of treatment of the CIDR Select protocol.

Arguably, given what we know regarding length of follicular waves (Savio et al., 1988; Sirois and Fortune, 1988), one might assume that a proportion of heifers may turn dominant follicles over on their own, prior to GnRH, independent of the need for GnRH to accomplish the same. More recently, Jaiswal et al. (2009) reported differences in 2-wave versus 3-wave patterns of ovarian follicular development in *Bos taurus* heifers. The prevalence of 2-wave versus 3-wave patterns was influenced by heifer age and/or maturity (Jaiswal et al., 2009). These authors (Jaiswal et al., 2009) suggest that more precise determination of predictive factors controlling patterns of follicular development in heifers will lead to the development of protocols that

facilitate improvements in estrous cycle control and enhance opportunities to expand the use of FTAI.

These considerations may relate to the study by Leitman et al. (2009b), but fail to explain the significant improvement in synchrony of estrus for 14-day CIDR-PG compared to CIDR Select treated heifers. Although response to GnRH in heifers is reported to be inconsistent when compared to cows (Macmillan and Thatcher, 1991; Pursley et al., 1995; Moreira et al., 2000), these data indicate that the addition of GnRH to a 14-d CIDR-PG protocol reduced the synchrony of estrus, despite similarities between treatments in estrous response. Schafer et al. (2006) and Leitman et al. (2009a) reported that the majority of heifers are on d 7 or 8 of the estrous cycle at the time GnRH is administered on d 23 of the CIDR Select protocol; therefore, the question arises as to the potential subsequent effect of administering GnRH to heifers at a point in their follicular wave at or during the time emergence of a new follicular wave begins. Given the fact that interval to estrus following PG was longer among CIDR Select versus 14-day CIDR-PG treated heifers, the effect of GnRH on subsequent follicular dynamics is in question.

Conception rate to AI (Table 11) tended to be greater for heifers assigned to 14-day CIDR-PG compared to CIDR Select, but was not influenced by estrous cyclicity status. Heifers assigned to 14-day CIDR-PG, however, had a higher pregnancy rate to AI compared to heifers assigned to CIDR Select. Pregnancy rate to AI (Table 11) was not influenced by estrous cyclicity status. These data point to the effectiveness of both protocols in inducing cyclicity in prepubertal heifers and successfully preparing heifers for breeding and subsequent pregnancy.

Perry et al. (2007) reported that use of protocols that control and/or manipulate follicular growth and development and increase the likelihood of ovulating optimal sized follicles may result in positive benefits on pregnancy rates in beef heifers. This is an important consideration based on studies that showed a relationship between ovulatory follicle size and pregnancy success in heifers (Perry et al., 2007) and cows (Vasconcelos et al., 2001; Lamb et al., 2001). Collectively, these reports support the concept that presynchronization is an effective means of manipulating follicle growth and development prior to a synchronized estrous period.

In summary from the experiment by Leitman et al. (2009b), similarities in estrous response following PG suggest that each of these long-term CIDR-based protocols was effective in synchronizing estrus in prepubertal and estrous-cycling beef heifers. The results from this experiment however, failed to confirm the hypothesis that the addition of GnRH on d 23 of the CIDR Select protocol results in a more highly synchronized estrus compared to 14-day CIDR-PG. Differences between treatments in the interval to estrus following PG, synchrony of estrus, and AI pregnancy rates during the synchronized period clearly suggested that further evaluation of these two CIDR-based protocols was required with and without the addition of GnRH and on the basis of estrous cyclicity status to determine the efficacy of these protocols for use in facilitating FTAI.



**Table 11.** Estrous response and interval to estrus after PGF<sub>2α</sub> (PG), and AI conception rates and pregnancy rates for heifers assigned to controlled internal drug release (CIDR) Select or 14-day CIDR-PG<sup>1</sup> (Leitman et al., 2009).

Item	CIDR Select	14-day CIDR-PG
Estrous response after PGF <sub>2α</sub>		
Proportion	136/144	138/141
%	94	98
Interval from PGF <sub>2α</sub> to estrus, h (LS mean ± SE)	61.5 ± 1.7 <sup>a</sup>	54.4 ± 1.7 <sup>b</sup>
Variance for interval to estrus after PGF <sub>2α</sub>	508 <sup>a</sup>	262 <sup>b</sup>
Conception rate to AI		
Proportion	78/135 <sup>c</sup>	92/137 <sup>d</sup>
%	58	67
Pregnancy rate to AI		
Proportion	78/143 <sup>e</sup>	92/140 <sup>f</sup>
%	55	66
Pregnancy rate at the end of the breeding season		
Proportion	116/143	113/140
%	81	81

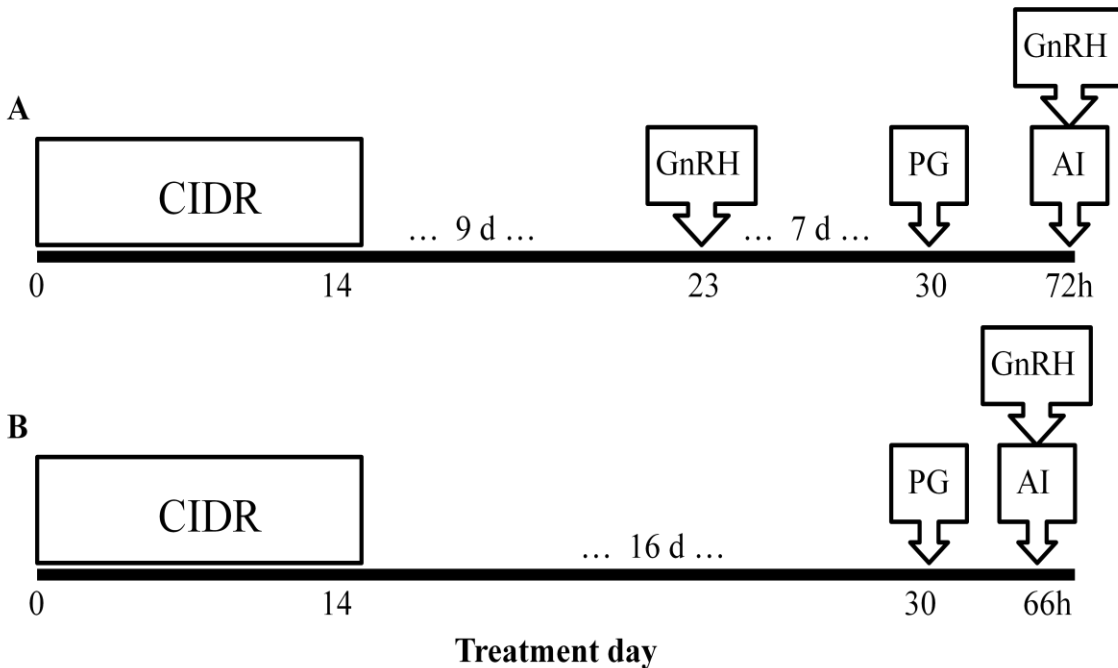
<sup>a,b</sup>Means and/or variances within rows with different superscripts are different ( $P \leq 0.01$ ).

<sup>c,d</sup>Means within rows with different superscripts tend to differ ( $P = 0.09$ ).

<sup>e,f</sup>Means within rows with different superscripts are different ( $P = 0.05$ ).

<sup>1</sup>See Figure 16 for a description of the treatment protocols.

Mallory (2009) conducted an experiment to compare FTAI pregnancy rates after treatment with the CIDR Select and 14-day CIDR-PG treatment protocols (Figure 18). Pregnancy rates resulting from FTAI tended to differ between treatments with the advantage to heifers assigned to the 14-day CIDR-PG protocol (Table 12). Pretreatment estrous cyclicity status did not affect FTAI pregnancy rate; however, there was a trend toward higher FTAI pregnancy rates among estrous-cycling heifers assigned to the 14-day CIDR-PG protocol compared to those assigned to CIDR Select. No difference was detected between prepubertal heifers treated with CIDR Select or 14-day CIDR-PG protocols, possibly due to the low number of pre- and peripubertal heifers within each treatment.



**Figure 18.** Treatment schedule for heifers assigned to the CIDR Select and 14-day CIDR-PG treatment protocols. Heifers assigned to the CIDR Select protocol received an EAZI-Breed CIDR insert from d 0 to d 14, GnRH on d 23, PG on d 30 followed by fixed-time AI at 72 h after PG administration. Heifers assigned to 14-day CIDR-PG received a CIDR insert from d 0 to 14 and PG on d 30 followed by fixed-time AI 66 h after PG administration (Mallory, 2009).

To date, no studies were reported comparing pregnancy rates resulting from FTAI for heifers assigned to the 14-day CIDR-PG protocol. Timing of insemination for heifers assigned to the 14-day CIDR-PG protocol in this study was based on previous reports by Leitman et al. (2009a, b) and Mallory et al. (2009). Peak estrous response in those studies occurred 48 to 60 h after PG, and the peak AI date was 3 d after PG. Mean intervals to estrus after PG for the three experiments were  $59.3 \pm 2.8$  h,  $54.4 \pm 1.7$  h, and  $56.2 \pm 2.5$  h, respectively (Leitman et al., 2009a, b; Mallory et al., 2010). Based on the consistency of these results, timing of insemination at 66 h following the administration of PG was chosen. Timing of insemination after the CIDR Select protocol (72 h) was based on previous studies from our laboratory (Busch et al., 2007; Leitman et al., 2008).

In summary, these data clearly indicate that the 14-day CIDR-PG protocol effectively synchronizes estrus prior to FTAI in beef heifers and provides an alternative to the CIDR Select protocol in facilitating expanded use of artificial insemination. This study further supports the results reported by Leitman et al. (2009b), indicating that GnRH is not required to successfully synchronize estrus prior to FTAI among heifers that are presynchronized with a 14-d CIDR treatment. Modification of the CIDR Select protocol to 14-day CIDR-PG allows producers to minimize trips through the chute and reduces cost associated with estrus synchronization and FTAI.

**Table 12.** AI pregnancy and final pregnancy rates for heifers assigned to CIDR Select or 14-day CIDR-PG treatment protocols (Mallory, 2009).

Item	CIDR Select	14-day CIDR-PG
Pregnancy rate to AI		
Proportion	98/192	124/200
Percent	51 <sup>a</sup>	62 <sup>b</sup>
Estrous Cycling		
Percent	83/158	102/162
	53 <sup>c</sup>	63 <sup>d</sup>
Prepubertal		
Percent	15/34	22/38
	44	58
Pregnancy rate at the end of the breeding season		
Proportion	164/192	166/200
Percent	85	83
Estrous Cycling		
Percent	135/158	134/162
	85	83
Prepubertal		
Percent	29/34	32/38
	85	84

<sup>a,b</sup>Means within rows with different superscripts tended to differ ( $P = 0.07$ ).

<sup>c,d</sup>Means within rows with different superscripts tended to differ ( $P = 0.06$ ).

### **Important Considerations Related to Choosing a Progestin-Based Protocol for Beef Heifers or Cows**

Use of MGA as part of any estrus synchronization protocol in beef cows constitutes an extra-label use of medicated feed that is prohibited by the Animal Medicinal Drug Use and Clarification Act and regulation 21 CFR 530.11(b). The feeding of MGA is specifically approved for estrus suppression in heifers only. Following removal of MGA from the ration allows heifers to return to estrus and be AI or bred in a synchronized time. Although 35 years of feeding MGA to beef cows and beef heifers has demonstrated MGA is safe, effective and economical, the feeding of MGA to adult cows is not an FDA approved label claim and therefore is strictly prohibited by the FDA. It is unfortunate that the MGA label does not include all reproductively mature beef cattle, but it does not.

The results reported in the proceedings from this conference, regarding use of the CIDR device in beef cows demonstrates that a viable alternative to MGA is available and approved for use by FDA/CVM. Table 13 summarizes results from field trials conducted in Missouri involving 63 herds and 7,028 cows. The pregnancy rates shown in Table 12 summarize results from FTAI in postpartum beef cows using the CO-Synch + CIDR protocol with insemination performed 66 hours after CIDR removal and PG administration. Bear in mind, no heat detection was

performed on these farms; cows were inseminated at the predetermined fixed-time without estrus detection. Pregnancy rates resulting from FTAI averaged 62% for the 63 herds. Interestingly, only 7 herds reported pregnancy rates lower than 50%. Producers that have used MGA to synchronize cows in the past should transition to CIDR to comply with FDA regulations concerning extra-label use of medicated feeds.

**Table 13.** Pregnancy rates resulting from field trials in Missouri following fixed-time AI in beef cows after administration of the CO-Synch + CIDR protocol with fixed time AI performed 66 hours after PG and CIDR removal (Patterson et al., unpublished data).

Item	Numbers		Pregnancy rate		
	Herds	Cows inseminated	AI pregnancy rate (mean)	AI pregnancy rate (range)	AI pregnancy rate (range)
Fixed time AI results	73	7028	4327/7028	62%	38-86%*

\*Only 7 of the 73 herds realized pregnancy rates < 50% resulting from fixed-time AI.

### **Management Considerations Related to Estrus Synchronization and Fixed-Time AI**

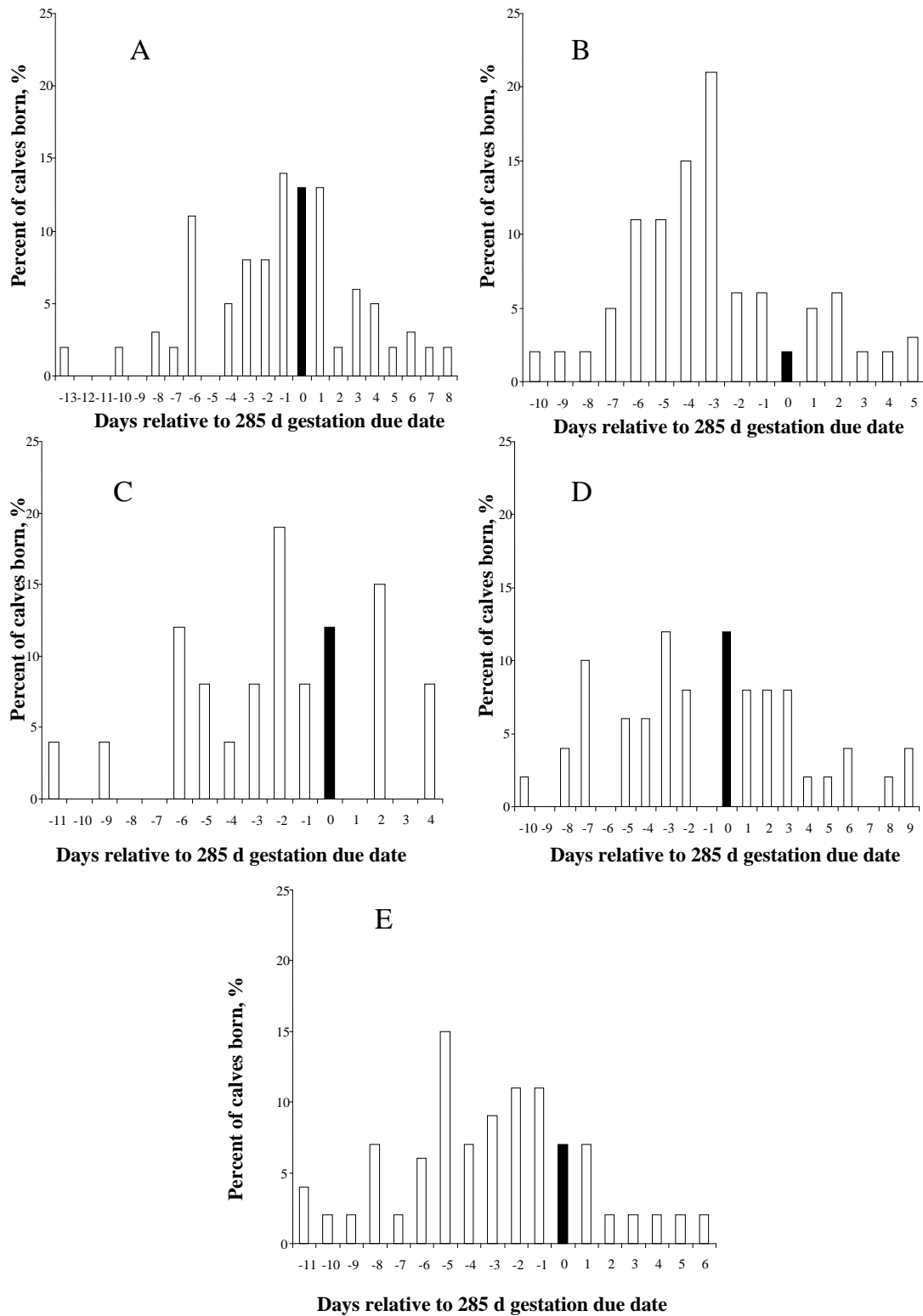
Our data support the use of estrus synchronization not only as a means of facilitating more rapid genetic improvement of beef herds, but perhaps, more importantly, as a powerful reproductive management tool. Profitability may be increased by reducing the extent to which labor is required during the calving period, and increasing the pounds of calf weaned that result from a more concentrated calving distribution and a resulting increase in the age of calves at weaning. Cumulative calving distribution patterns indicate that in many cases over 85% of pregnant cows among synchronized herds will calve within the first 30 days of the calving period (Perry et al., 2002 ; Stegner et al., 2004a,b; Bader et al., 2005; Schafer et al., 2007; Busch et al., 2008).

More recently, calving dates for cows that conceived on the same day to fixed-time AI were recorded to address concerns that pertain to the subsequent calving period (Bader et al., 2005). Calf birth dates were recorded for cows that conceived to fixed-time AI (Figure 19) at each location involved in the study by Bader et al. (2005). The resulting calving distribution for cows that conceived to the respective sires at each of the locations in the two treatments is illustrated in Figure 19. Calving distribution patterns differed among individual sires (Table 14;  $P < 0.05$ ). Calving distribution among cows that conceived to fixed-time AI for Location 1 (sires A and B) was 21 and 16 days, respectively. Distributions for Location 2 (sires C and D) were 16 and 20 days, respectively. The calving distribution among cows at location 3 (sire E), was 18 days. Sire B at Location 1 and sire E at Location 3 was the same sire. Cows that conceived on the same day gave birth to calves over a 16 to 21 day period, dependent upon the respective sire. These distributions indicate that successful use of FTAI will not result in an overwhelming number of cows calving on the same day(s). This furthermore suggests that current management practices will not need to be greatly altered to accommodate the early portion of the calving season.

**Table 14.** Comparison of gestation lengths (Mean  $\pm$  SE) among AI sires and locations.

Location	Sire	Gestation length, days	Range, days
1	A	283.5 $\pm$ 0.5	272 - 292
	B <sup>a</sup>	282.1 $\pm$ 0.5	275 - 290
2	C	282.9 $\pm$ 0.8	274 - 289
	D	284.1 $\pm$ 0.6	275 - 294
3	E <sup>a</sup>	282.0 $\pm$ 0.5	274 - 291

<sup>a</sup>Sire B at location 1 and sire E at location 3 are the same sire.  
From Bader et al. (2005).



**Figure 19.** Calving distribution patterns at the respective locations for cows that conceived to fixed-time AI. Calving dates among cows that conceived on the same day to the respective sires (A, B, C, D, and E) were 21, 16, 16, 20, and 18 days. Sire B at Location 1 and sire E at Location 3 were the same sire. The shaded bar in each graph represents an anticipated 285 day gestation due date. From Bader et al. (2005).

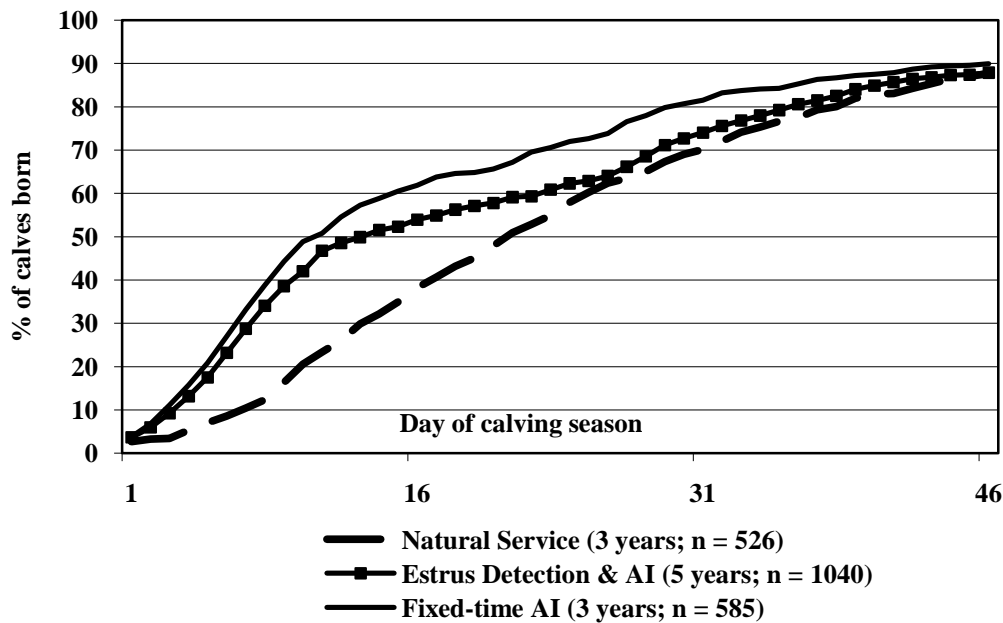
## Consider the Impact of Estrus Synchronization on Calving Distribution

Economic considerations related to use of estrus synchronization and choice of the various protocols to use in beef heifers and cows was reviewed by Johnson and Jones (2004). Hughes (2005) reported that opportunities to increase profits for cow-calf operations lie in managing females from the later calving intervals forward toward the first and second 21-day calving intervals. Hughes (2005) reports that added pounds are the economic reward to tightening up the calving interval. The CHAPS benchmark values utilize IRM-SPA guidelines for operating high production herds. These guidelines suggest that 61% of the calves within a herd should be born by day 21 of the calving period, 85% by day 42, and 94% by day 63. Hughes (2005) goes on to say that today's high market prices are generating big economic rewards to intensified management, but more specifically "management as usual" may be what is amiss for many cow calf producers.

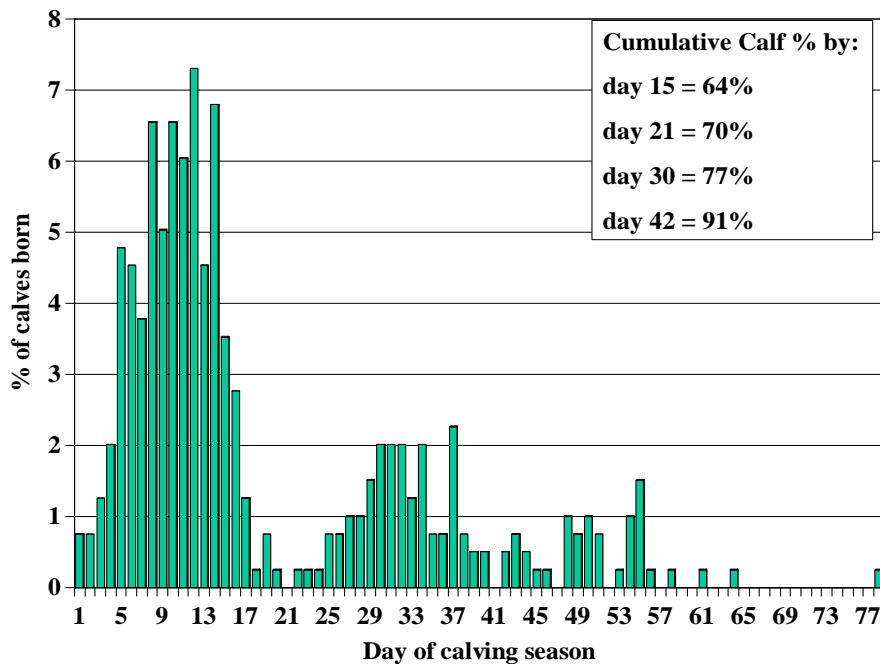
Figure 20 illustrates the cumulative calving percentages for the University of Missouri Thompson farm over an 11-year period. The graph compares the percentages of calves born during years when only natural service was used, followed by estrus synchronization and AI performed on the basis of observed heat, and finally fixed-time AI. The graph illustrates the respective distributions on the basis of days in the calving season. Notice the increased percentage of calves born early in the calving period during years when AI was performed on the basis of observed heat or at predetermined fixed times in comparison to years in which only natural service was practiced.

Figure 21 illustrates the combined calving data for 3 of the 4 locations in the study by Schafer (2005). Data from the fourth location was not included in the summary since cows that failed to conceive to AI were sold prior to the calving period. It is interesting to note that in comparison to the recommendation by Hughes (2005), 64% of the cows in this study had calved by day 15, 70% by day 21, 77% by day 30, and 91% by day 42. The economic reward for improvements in calf weaning weight that result from an increase in calf age at weaning, in many cases may offset the cost of implementing estrus synchronization in beef herds.

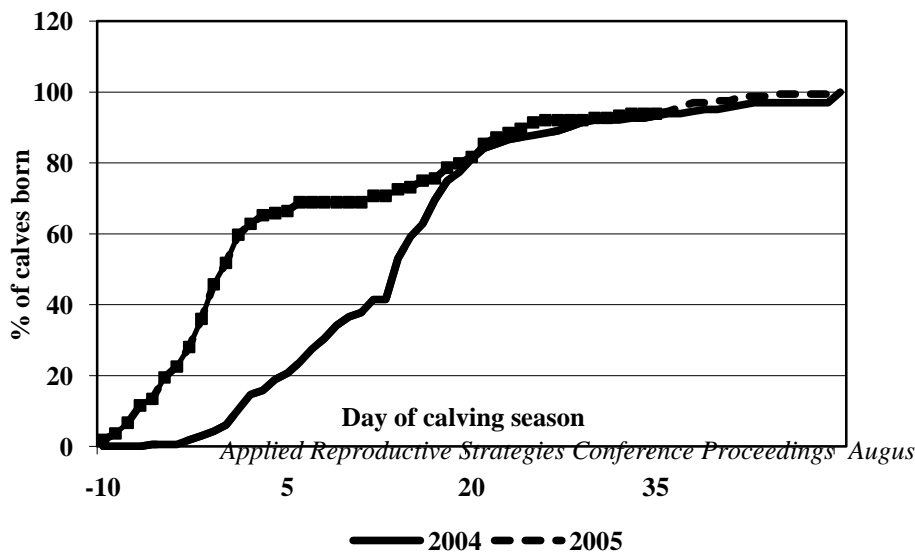
Finally, Figure 22 illustrates the calving profile for cows at the University of Missouri Forage Systems Research Center in Linneus, MO, over a two year period. This herd maintains a 45-day breeding season, and until the spring of 2004, estrus synchronization and AI were not utilized. Figure 22 illustrates the calving profile of cows that calved during the spring of 2004 as a result of natural service during the 2003 breeding season. Figure 22 also illustrates the calving profile for cows that calved during the spring of 2005 as a result of fixed time AI performed during the 2004 breeding season (Schafer, 2005). This herd has been intensively managed over the years to breed successfully in a 45 day period with natural service. Notice, however, the increased percentage of cows that calved early in the calving period as a result of fixed-time AI performed during the previous year's breeding season. Estrus synchronization at this location in one year resulted in an increase of 7 days postpartum among cows at the start of the breeding period, which translates into an increase in calf age at weaning of seven calf days. These figures (Figures 20, 21, 22) collectively demonstrate that estrus synchronization can be used effectively to influence calving distribution patterns during the subsequent calving period, which in turn impacts the economics of herds at weaning time.



**Figure 20.** Cumulative calf crops for the first 46 days of calving season over 11 years for cows at the University of Missouri Thompson Farm combining years involving natural service, estrus synchronization and AI performed on the basis of observed heat, and fixed-time AI (Schafer and Patterson, unpublished data).



**Figure 21.** Calving distributions combined for 3 of the 4 locations in the study by Schafer (2005).



**Figure 22.** Calving profiles for cows at the University of Missouri Forage Systems Research Center in Linneus, MO, over a 2 year period. This herd maintains a 45-day breeding season and until the spring of 2004 estrus synchronization and AI had not been utilized. The figure illustrates the calving profiles of cows that calved during the spring of 2004 as a result of natural service during the 2003 breeding season, and calving profiles for cows that calved during the spring of 2005 as a result of fixed time AI performed during the 2004 breeding season (Schafer, 2005).



## Summary and Conclusions

Expanded use of AI and/or adoption of emerging reproductive technologies for beef heifers and cows require precise methods of estrous cycle control. Effective control of the estrous cycle requires the synchronization of both luteal and follicular functions. Efforts to develop more effective estrus synchronization protocols have focused on synchronizing follicular waves by injecting GnRH followed 7 days later by injection of PG (Ovsynch, CO-Synch, Select Synch). A factor contributing to reduced synchronized pregnancy rates among heifers treated with the preceding protocols is the extreme variability in response to GnRH based on the day of the cycle GnRH is administered; whereas, 5 to 15% of cows treated with the preceding protocols exhibit estrus on or before PG injection. New protocols for inducing and synchronizing a fertile estrus in replacement beef heifers and postpartum beef cows in which progestins are used provide new opportunities for beef producers to synchronize estrus and ovulation and facilitate FTAI. Table 15 provides a summary of the various estrus synchronization protocols for use in replacement beef heifers. This table includes estrous response for the respective treatments and the synchronized pregnancy rate that resulted. These data represent results from our own published work, in addition to published studies with heifers by Lucy et al. (2001), Lamb et al. (2006), and Tauck et al. (2007). These data suggest that new methods of inducing and synchronizing estrus for replacement beef heifers now create the opportunity to significantly expand the use of AI in the U.S. cowherd.

**Table 15.** Comparison of estrous response and fertility in beef heifers after treatment with various estrus synchronization protocols.

Treatment	Estrous response		Synchronized pregnancy rate	
<u>AI based on detected estrus</u>				
MGA-PG 14-19 d	1129/1302	87%	768/1302	59%
MGA <sup>®</sup> Select	433/499	87%	280/499	56%
CIDR-PG (d6)	200/285	70%	112/830	39%
CIDR Select	896/974	92%	577/974	59%
14-day CIDR-PG	394/422	93%	241/422	57%
<u>Heat detect &amp; fixed-time AI</u>				
CIDR-PG (d7): 84 hr			282/517	55%
Select Synch + CIDR: 84 hr			289/504	57%
14 d CIDR + PG: 72 hr			48/77	62%
14 d MGA + PG: 72hr			52/79	66%
<u>AI performed at predetermined fixed times with no estrus detection</u>				
7-day CIDR-PG	Fixed-time AI @ 60 hr		258/525	49%
CO-Synch + CIDR	Fixed-time AI @ 60 hr		282/531	53%
CO-Synch + CIDR	Fixed-time AI @ 54 hr		51/109	47%
CIDR Select	Fixed-time AI @ 72 hr		616/1051	58%
14-day CIDR-PG	Fixed-time AI @ 66 hr		988/1518	65%

## Literature Cited

- Anderson, L. H., C. M. McDowell, and M. L. Day. 1996. Progestin-induced puberty and secretion of luteinizing hormone in heifers. *Biol. Reprod.* 54:1025-1031.
- ASBIA. 2004. Report of semen sales. Brazilian Association of Artificial Insemination. São Paulo, Brazil.
- Atkins, J. A., D. C. Busch, J. F. Bader, D. H. Keisler, D. J. Patterson, M. C. Lucy, and M. F. Smith. 2008. Gonadotropin-releasing hormone-induced ovulation and luteinizing hormone release in beef heifers: Effect of day of the cycle. *J. Anim. Sci.* 86:83-93.
- Bader, J. F., F.N. Kojima, D.J. Schafer, J.E. Stegner, M.R. Ellersieck, M.F. Smith, and D.J. Patterson. 2005. A comparison of two progestin-based protocols to synchronize ovulation and facilitate fixed-time artificial insemination in postpartum beef cows. *J. Anim. Sci.* 83:136-143.
- Bao, B., and H. A. Garverick. 1998. Expression of steroidogenic enzyme and gonadotropin receptor genes in bovine follicles during ovarian follicular waves: A review. *J. Anim. Sci.* 76:1903-1921.
- Berardinelli, J. G., R. A. Dailey, R. L. Butcher, and E. K. Inskeep. 1979. Source of progesterone prior to puberty in beef heifers. *J. Anim. Sci.* 49:1276-1281.
- Brown, L. N., K. G. Odde, D. G. LeFever, M. E. King, and C. J. Neubauer. 1988. Comparison of MGA-PGF<sub>2α</sub> to Syncro-Mate B for estrous synchronization in beef heifers. *Theriogenology* 30:1.
- Burfening, P. J. 1979. Induction of puberty and subsequent reproductive performance. *Theriogenology* 12:215-221.
- Burke, J. M., R. L. d la Sota, C. A. Risco, C. R. Staples, E.J. P. Schmitt, and W. W. Thatcher. 1996. Evaluation of timed insemination using a gonadotropin-releasing agonist in lactating dairy cows. *J. Dairy Sci.* 79:1385-1393.
- Busch, D. C., D. J. Wilson, D. J. Schafer, N. R. Leitman, J. K. Haden, M. R. Ellersieck, M. F. Smith, and D. J. Patterson. 2007. Comparison of CIDR-based estrus synchronization protocols prior to fixed-time AI on pregnancy rate in beef heifers. *J. Anim. Sci.* 85:1933-1939.
- Busch, D. C., D. J. Schafer, D. J. Wilson, D. A. Mallory, N. R. Leitman, J. K. Haden, M. R. Ellersieck, M. F. Smith, and D. J. Patterson. 2008. Timing of artificial insemination in postpartum beef cows following administration of the CO-Synch + controlled internal drug release protocol. *J. Anim. Sci.* 86:1519-1525.
- Deutscher, G. H. 2000. Extending interval from seventeen to nineteen days in the melengestrol acetate-prostaglandin estrous synchronization program for heifers. *Prof. Anim. Sci.* 16:164-168.
- Dziuk, P. J., and R. A. Bellows. 1983. Management of reproduction in beef cattle, sheep and pigs. *J. Anim. Sci.* 57(Suppl.2), 355.
- Federal Register. March 26, 1997. New animal drugs for use in animal feeds; Melengestrol Acetate. Vol. 62. No.58. pp.14304-14305.
- Fortune, J. E., J. Sirois, and S. M. Quirk. 1988. The growth and differentiation of ovarian follicles during the bovine estrous cycle. *Theriogenology* 29:95-109.
- Garcia-Winder, M., P. E. Lewis, D. R. Deaver, V. G. Smith, G. S. Lewis, and E. K. Inskeep. 1986. Endocrine profiles associated with the life span of induced corpora lutea in postpartum beef cows. *J. Anim. Sci.* 62:1353-1362.

- Garverick, H. A., R. G. Elmore, D. H. Vaillancourt, and A. J. Sharp. 1980. Ovarian response to gonadotropin-releasing hormone in postpartum dairy cows. *Amer. J. Vet. Res.* 41:1582-1585.
- Geary, T. W., J. C. Whittier, and D. G. LeFever. 1998. Effect of calf removal on pregnancy rates of cows synchronized with the Ovsynch or CO-Synch protocol. *J. Anim. Sci.* 81(Suppl.1):278.
- Geary, T. W., E. R. Downing, J. E. Bruemmer, and J. C. Whittier. 2000. Ovarian and estrous response of suckled beef cows to the Select Synch estrous synchronization protocol. *Prof. Anim.Sci.* 16:1-5.
- Gonzalez-Padilla, E., R. Ruiz, D. LeFever, A. Denham, and J. N. Wiltbank. 1975. Puberty in beef heifers. III. Induction of fertile estrus. *J. Anim. Sci.* 40:1110-1118.
- Hall, J. B., R. B. Staigmiller, R. E. Short, R. A. Bellows, M. D. MacNeil, and S. E. Bellows. 1997. Effect of age and pattern of gain on induction of puberty with a progestin in beef heifers. *J. Anim. Sci.* 75:1606-1611.
- Hansel, W., P. V. Malven, and D. L. Black. 1961. Estrous cycle regulation in the bovine. *J. Anim. Sci.* 20:621-625.
- Henricks, D. M., J. R. Hill, and J. F. Dickey. 1973. Plasma ovarian hormone levels and fertility in beef heifers treated with melengestrol acetate (MGA). *J. Anim. Sci.* 37:1169-1175.
- Hughes, H. Something's amiss with profit part 1. BEEF. February 1, 2005.
- Imwalle, D. B., D. J. Patterson, K. K. Schillo. 1998. Effects of melengestrol acetate on onset of puberty, follicular growth, and patterns of luteinizing hormone secretion in beef heifers. *Biol. Reprod.* 58:1432-1436.
- Imwalle, D. B., D. L. Fernandez, and K. K. Schillo. 2002. Melengestrol acetate blocks the preovulatory surge of luteinizing hormone, the expression of behavioral estrus and ovulation in beef heifers. *J. Anim. Sci.* 80:1280-1284.
- Jaiswal, R. S., J. Singh, L. Marshall, and G. P. Adams. 2009. Repeatability of 2-wave and 3-wave patterns of ovarian follicular development during the bovine estrous cycle. *Theriogenology* 72: 81-90.
- Johnson, S. K., and R. Jones. 2004. Cost and comparisons of estrous synchronization systems. In proceedings Applied Reproductive Strategies in Beef Cattle. North Platte, NE. pp103-115.
- Kojima, F. N., B. E. Salfen, J. F. Bader, W. A. Ricke, M. C. Lucy, M. F. Smith, and D. J. Patterson. 2000. Development of an estrus synchronization protocol for beef cattle with short-term feeding of melengestrol acetate: 7-11 Synch. *J. Anim. Sci.* 78:2186-2191.
- Kojima, F. N., J. F. Bader, J. E. Stegner, D. J. Schafer, J. C. Clement, R. L. Eakins, M. F. Smith, and D. J. Patterson. 2004. Substituting EAZI-BREED CIDR inserts (CIDR) for melengestrol acetate (MGA) in the MGA Select protocol in beef heifers. *J. Anim. Sci.* 82(Suppl. 1):255.
- Lamb, G. C., D. W. Nix, J. S. Stevenson, and L. R. Corah. 2000. Prolonging the MGA-prostaglandin F<sub>2α</sub> interval from 17 to 19 days in an estrus synchronization system for heifers. *Theriogenology* 53:691-698.
- Lamb, G. C., J. S. Stevenson, D. J. Kesler, H. A. Garverick, D. R. Brown, and B. E. Salfen. 2001. Inclusion of an intravaginal progesterone insert plus GnRH and prostaglandin F<sub>2α</sub> for ovulation control in postpartum suckled beef cows. *J. Anim. Sci.* 79:2253-2259.

- Lamb, G. C., J. E. Larson, T. W. Geary, J. S. Stevenson, S. K. Johnson, M. L. Day, R. P. Ansotegui, D. J. Kesler, J. M. DeJarnette, and D. G. Landblom. 2006. Synchronization of estrus and artificial insemination in replacement beef heifers using gonadotropin-releasing hormone, prostaglandin F, and progesterone. *J. Anim. Sci.* 84:3000-3009.
- Lamond, D. R. 1964. Synchronization of ovarian cycles in sheep and cattle. *Anim. Breed. Abstr.* 32:269-285.
- Lauderdale, J. W. 1972. Effects of prostaglandin F<sub>2α</sub> on pregnancy and estrous cycle of cattle. *J. Anim. Sci.* 35(Suppl. 1):246.
- Lauderdale, J. W., B. E. Seguin, J. N. Stellflug, J. R. Chenault, W. W. Thatcher, C. K. Vincent, and A. F. Loyancano. 1974. Fertility of cattle following PGF<sub>2α</sub> injection. *J. Anim. Sci.* 38:964-967.
- Leitman, N. R., D. C. Busch, J. F. Bader, D. A. Mallory, D. J. Wilson, M. C. Lucy, M. R. Ellersieck, M. F. Smith, and D. J. Patterson. 2008. Comparison of protocols to synchronize estrus and ovulation in estrous cycling and prepubertal beef heifers. *J. Anim. Sci.* 86:1808-1818.
- Leitman, N. R., D. C. Busch, D. A. Mallory, D. J. Wilson, M. R. Ellersieck, M. F. Smith, and D. J. Patterson. 2009a. Comparison of long-term CIDR-based protocols to synchronize estrus in beef heifers. *Animal Reproduction Science* 114: 345-355.
- Leitman, N. R., D. C. Busch, D. J. Wilson, D. A. Mallory, M. R. Ellersieck, M. F. Smith, and D. J. Patterson. 2009b. Comparison of controlled internal drug release insert-based protocols to synchronize estrus in prepubertal and estrous-cycling beef heifers. *J. Anim. Sci.* 87: 3976-3982.
- Liehr, R. A., G. B. Marion, and H. H. Olson. 1972. Effects of prostaglandin on cattle estrous cycles. *J. Anim. Sci.* 35(Suppl. 1):247.
- Lucy, M. C., H. J. Billings, W. R. Butler, L. R. Ehnis, M. J. Fields, D. J. Kesler, J. E. Kinder, R. C. Mattos, R. E. Short, W. W. Thatcher, R. P. Wettemann, J. V. Yelich, and H. D. Hafs. 2001. Efficacy of an intravaginal progesterone insert and an injection of PG F<sub>2α</sub> for synchronizing estrus and shortening the interval to pregnancy in postpartum beef cows, periparturient beef heifers, and dairy heifers. *J. Anim. Sci.* 79:9823-995.
- Macmillan, K. L., and H. V. Henderson. 1984. Analyses of the variation in the interval of prostaglandin F<sub>2α</sub> to oestrus as a method of studying patterns of follicle development during diestrus in dairy cows. *Anim. Reprod. Sci.* 6:245-254.
- Macmillan, K. L., and A. J. Peterson. 1993. A new intravaginal progesterone releasing device for cattle (CIDR-B) for oestrous synchronization, increasing pregnancy rates and the treatment of post-partum anoestrus. *Anim. Reprod. Sci.* 33:1-25.
- Macmillan, K. L., and W. W. Thatcher. 1991. Effects of an agonist on gonadotropin-releasing hormone on ovarian follicles in cattle. *Biol Reprod* 45: 883-889.
- Mallory, D. A., 2009. Comparison of long-term progestin-based protocols to synchronize estrus in beef heifers. M. S. Thesis. University of Missouri.
- Mallory, D.A., D.J. Wilson, D.C. Busch, M.R. Ellersieck, M.F. Smith, and D.J. Patterson. 2010. Comparison of long-term progestin-based estrus synchronization protocols in beef heifers. *J. Anim. Sci.* In press.
- Moreira, F., R. L. de la Sota, T. Diaz, and W. W. Thatcher. 2000. Effect of day of the estrous cycle at the initiation of a timed artificial insemination protocol on reproductive responses in dairy heifers. *J. Anim. Sci.* 78: 1568-1576.

- NAAB. 2004. Report of semen sales and custom freezing. National Association of Animal Breeders, Columbia, MO
- Nellor, J.E., and H.H. Cole. 1956. The hormonal control of estrus and ovulation in the beef heifer. *J. Anim. Sci.* 15:650-661.
- NAHMS. 1998. Part IV. Changes in the U.S. Beef Cow-Calf Industry. 1993-1997. pp. 1. USDA-APHIS Center for Epidemiology and Animal Health, Fort Collins, CO.
- Patterson, D. J., G. H. Kiracofe, J. S. Stevenson, and L. R. Corah. 1989. Control of the bovine estrous cycle with melengestrol acetate (MGA): A review. *J. Anim. Sci.* 67:1895-1906.
- Patterson, D. J., L. R. Corah, and J. R. Brethour. 1990. Response of prepubertal *Bos taurus* and *Bos indicus* x *Bos taurus* heifers to melengestrol acetate with or without gonadotropin-releasing hormone. *Theriogenology* 33:661-669.
- Patterson, D. J., J. M. Kearnan, N. W. Bradley, K. K. Schillo, and B. L. Woods. 1993. Estrus response and fertility in yearling beef heifers after chronic treatment with an oral progestogen followed by prostaglandin F<sub>2α</sub>. University of Kentucky Beef Cattle Research Report. Progress Report 353. Pp. 31-33.
- Patterson, D. J., S. L. Wood, and R. F. Randle. 2000a. Procedures that support reproductive management of replacement beef heifers. *Proc. Am.Soc. Anim. Sci.*, 1999. Available at: <http://www.asas.org/jas/symposia/proceedings/0902.pdf>. Accessed August 3, 2000.
- Patterson, D. J., S. L. Wood, F. N. Kojima, and M. F. Smith. 2000b. Current and emerging methods to synchronize estrus with melengestrol acetate. In: 49<sup>th</sup> Annual Beef Cattle Short Course Proceedings “Biotechnologies of Reproductive Biology”. Pp. 45-66. University of Florida, Gainesville.
- Patterson, D.J., F.N. Kojima, and M.F. Smith. 2003. A review of methods to synchronize estrus in replacement heifers and postpartum beef cows. *J. Anim. Sci.* 81(E. Suppl. 2):E166-E177. Online.Available: <http://www.asas.org/symposia/03esupp2/jas2402.pdf>. Accessed June 19, 2003.
- Patterson, D. J., D. J. Schafer, D. C. Busch, N. R. Leitman, D. J. Wilson, and M. F. Smith. 2006. Review of estrus synchronization systems: MGA. In: *Proceedings Applied Reproductive Strategies in Beef Cattle*. St. Joseph, MO. Pp. 63-103.
- Perry, G.A., M.F. Smith, and D.J. Patterson. 2002. Evaluation of a fixed-time artificial insemination protocol for postpartum suckled beef cows. *J. Anim. Sci.* 80:3060-3064.
- Perry, G. A., M. F. Smith, A. J. Roberts, M. D. MacNeil, and T. W. Geary. 2007. Relationship between size of the ovulatory follicle and pregnancy success in beef heifers. *J. Anim. Sci.* 85:684-689.
- Prybil, M. K., and W. R. Butler. 1978. The relationship between progesterone secretion and the initiation of ovulation in postpartum beef cows. *J. Anim. Sci.* 47(Suppl. 1):383.
- Pursley, J. R., M. O. Mee, and M. C. Wiltbank. 1995. Synchronization of ovulation in dairy cows using PGF<sub>2α</sub> and GnRH. *Theriogenology* 44:915-924.
- Pursley, J. R., M. W. Kosorok, and M. C. Wiltbank. 1997a. Reproductive management of lactating dairy cows using synchronization of ovulation. *J. Dairy Sci.*80:301-306.
- Pursley, J. R., M. C. Wiltbank, J. S. Stevenson, J. S. Ottobre, H. A. Garverick, and L. L. Anderson. 1997b. Pregnancy rates in cows and heifers inseminated at a synchronized ovulation or synchronized estrus. *J. Dairy Sci.* 80:295-300.

- Pursley, J. R., R. W. Silcox, and M. C. Wiltbank. 1998. Effect of time of artificial insemination on pregnancy rates, calving rates, pregnancy loss, and gender ratio after synchronization of ovulation in lactating dairy cows. *J. Dairy Sci.* 81:2139-2144.
- Rawlings, N. C., L. Weir, B. Todd, J. Manns, and J. Hyland. 1980. Some endocrine changes associated with the postpartum period of the suckling beef cow. *J. Reprod. Fertil.* 60:301-308.
- Rowson, L.E.A., R. Tervit, and A. Brand. 1972. The use of prostaglandin for synchronization of oestrus in cattle. *J. Reprod. Fertil.* 29:145 (Abstr).
- Sartori, R., P. M. Fricke, J. C. Ferreira, O. J. Ginther, and M. C. Wiltbank. 2001. Follicular deviation and acquisition of ovulatory capacity in bovine follicles. *Biol. Reprod.* 65:1403-1409.
- Savio, J. D., L. Kennan, M. P. Boland, and J. F. Roche. 1988. Pattern of growth of dominant follicles during the oestrus cycle in heifers. *J. Reprod. Fertil.* 83:663-671.
- Schafer, D. J. 2005. Comparison of progestin based protocols to synchronize estrus and ovulation in beef cows. M.S. Thesis. University of Missouri, Columbia.
- Schafer, D. J., D. C. Busch, M. F. Smith, and D. J. Patterson. 2006. Characterization of follicular dynamics, timing of estrus, and response to GnRH and PG in replacement beef heifers after presynchronization with a 14-day CIDR. *J. Anim. Sci.* 84(Suppl. 1):49.
- Schafer, D. J., J. F. Bader, J. P. Meyer, J. K. Haden, M. R. Ellersieck, M. C. Lucy, M. F. Smith, and D. J. Patterson. 2007. Comparison of progestin based protocols to synchronize estrus and ovulation before fixed-time artificial insemination in postpartum beef cows. *J. Anim. Sci.* 85:1940-1945.
- Schafer, D.W., J.S. Brinks, and D.G. LeFever. 1990. Increased calf weaning weight and weight via estrus synchronization. Beef Program Report. Colorado State University. pp. 115-124.
- Schmitt, E. J.-P., T. Diaz, M. Drost, and W. W. Thatcher. 1996. Use of a gonadotropin-releasing hormone agonist or human chorionic gonadotropin for timed insemination in cattle. *J. Anim. Sci.* 74:1084-1091.
- Seidel, G. E. Jr. 1995. Reproductive biotechnologies for profitable beef production. Proc. Beef Improvement Federation. Sheridan, WY. Pp. 28-39.
- Sheffel, C. E., B.R. Pratt, W. L. Ferrell, and E. K. Inskeep. 1982. Induced corpora lutea in the postpartum beef cow. II. Effects of treatment with progestogen and gonadotropins. *J. Anim. Sci.* 54:830-836.
- Sirois, J., and J. E. Fortune. 1988. Ovarian follicular dynamics during the estrous cycle in heifers monitored by real-time ultrasonography. *Biol. Reprod.* 39:308-317.
- Smith, R. K., and M. L. Day. 1990. Mechanism of induction of puberty in beef heifers with melengestrol acetate. In: Ohio Beef Cattle Res. and Ind. Rep. pp 137-142. Columbus, OH.
- Stegner, J. E., F. N. Kojima, M. R. Ellersieck, M. C. Lucy, M. F. Smith, and D. J. Patterson. 2004a. A comparison of progestin-based protocols to synchronize estrus in postpartum beef cows. *J. Anim. Sci.* 82:1016-1021.
- Stegner, J. E., J. F. Bader, F.N. Kojima, M.R. Ellersieck, M.F. Smith, and D.J. Patterson. 2004b. Fixed-time artificial insemination of postpartum beef cows at 72 or 80 hours after treatment with the MGA<sup>®</sup> Select protocol. *Theriogenology* 61:1299-1305.

- Stevenson, J. S., G. C. Lamb, J. A. Cartmill, B. A. Hensley, S. Z. El-Zarkouny, and T. J. Marple. 1999. Synchronizing estrus in replacement beef heifers using GnRH, melengestrol acetate, and PGF<sub>2α</sub>. *J. Anim. Sci.* 77(Suppl. 1):225.
- Tauck, S.A., J.R. C. Wilkinson, J. R. Olsen, J. N. Janitell, and J. G. Berardinelli. 2007. Comparison of controlled internal drug release device and melengestrol acetate as progestin sources in an estrous synchronization protocol for beef heifers. *Theriogenology* 68:162-167.
- Thatcher, W. W., M. Drost, J. D. Savio, K. L. Macmillan, K. W. Entwistle, E. J. Schmitt, R. L. De La Sota, and G. R. Morris. 1993. New clinical uses of GnRH and its analogues in cattle. *Anim. Reprod. Sci.* 33:27-49.
- Thimonier, J., D. Chupin, and J. Pelot. 1975. Synchronization of estrus in heifers and cyclic cows with progestogens and prostaglandin analogues alone or in combination. *Ann. Biol. Anim. Biochim. Biophys.* 15:437-449.
- Twagiramungu, H., L. A. Guilbault, J. Proulx, and J. J. Dufour. 1992a. Synchronization of estrus and fertility in beef cattle with two injections of Buserelin and prostaglandin. *Theriogenology* 38:1131-1144.
- Twagiramungu, H., L. A. Guilbault, J. Proulx, P. Villeneuve, and J. J. Dufour. 1992b. Influence of an agonist of gonadotropin-releasing hormone (Buserelin) on estrus synchronization and fertility in beef cows. *J. Anim. Sci.* 70:1904-1910.
- Twagiramungu, H., L. A. Guilbault, and J. J. Dufour. 1995. Synchronization of ovarian follicular waves with a gonadotropin-releasing hormone agonist to increase the precision of estrus in cattle: A review. *J. Anim. Sci.* 73:3141-3151.
- Ulberg, L. C., R. E. Christian, and L. E. Casida. 1951. Ovarian response in heifers to progesterone injections. *J. Anim. Sci.* 10:752-759.
- Vasconcelos, J. L., R. Sartori, H. N. Oliveira, J. G. Guenther, and M. C. Wiltbank. 2001. Reduction in size of the ovulatory follicle reduces subsequent luteal size and pregnancy rate. *Theriogenology* 56:300-314.
- Wetteman, R. P., and H. D. Hafs. 1973. Pituitary and gonadal hormones associated with fertile and nonfertile inseminations at synchronized and control estrus. *J. Anim. Sci.* 36:716-721.
- Wood, S. L., M. C. Lucy, M. F. Smith, and D. J. Patterson. 2001. Improved synchrony of estrus and ovulation with addition of GnRH to a melengestrol acetate-prostaglandin F<sub>2α</sub> estrus synchronization treatment in beef heifers. *J. Anim. Sci.* 79:2210-2216.
- Wood-Follis, S. L., F. N. Kojima, M. C. Lucy, M. F. Smith, and D. J. Patterson. 2004. Estrus synchronization in beef heifers with progestin-based protocols. I. Differences in response based on pubertal status at the initiation of treatment. *Theriogenology* 62:1518-1528.
- Zimbelman, R. G. 1963. Maintenance of pregnancy in heifers with oral progestogens. *J. Anim. Sci.* 22:868.
- Zimbelman, R. G., and L. W. Smith. 1966. Control of ovulation in cattle with melengestrol acetate. I. Effect of dosage and route of administration. *J. Reprod. Fertil. (Suppl.1)*:185.
- Zimbelman, R. G., J. W. Lauderdale, J. H. Sokolowski, and T. G. Schalk. 1970. Safety and pharmacologic evaluations of melengestrol acetate in cattle and other animals. A review. *J.A.V.M.A.* 157:1528-1536.